

LIBRERIA  
CENTRALE

PROVA  
LIBRERIA  
CENTRALE  
S  
3



UNIVERSITA'  
BIBLIOTECA CENTRALE  
ARCHIVIO  
FACOLTA' D'INGEGNERIA  
— PADOVA —

BOLOGNA ENRICO  
LEGATORE DI LIBRI  
ROVIGO

R. SCUOLA  
BIBLIOTECA DELLA  
C  
III  
10  
DI INGEGNERIA  
— PADOVA —



ARCHIVIO

Ms. III, 2

626.21.014

REC 12730

X

D

166.3

o



CORSO TEORICO

SUI

# COSTRUZIONE DEI

AD

DEGLI INGEGNERI,

DEGLI ALLIEVI DELLE S

PER L'IN

PIO D<sup>B</sup> C

PROFESSORE DI PONTI, STRADE E FERROVIE  
ANNESSA ALL'UNIVERSITÀ

SECONDA

riordinata con

L'opera si compone di un Volume di testo  
e di un Atlante

ATLANTE

di 45 tavole



EDITA

AUG. FED. NEGRO

Via Alfieri, N° 4

TORINO

18







Fig.1

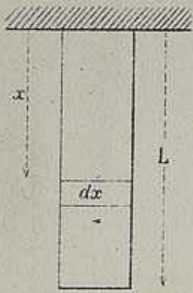

Fig.2

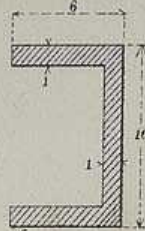

Fig.3

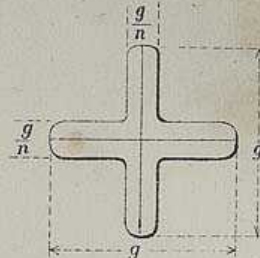

Fig.4

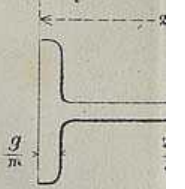

Fig.6

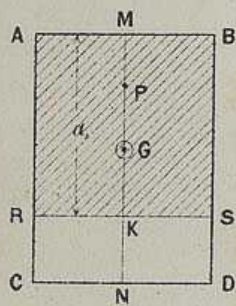

Fig.11

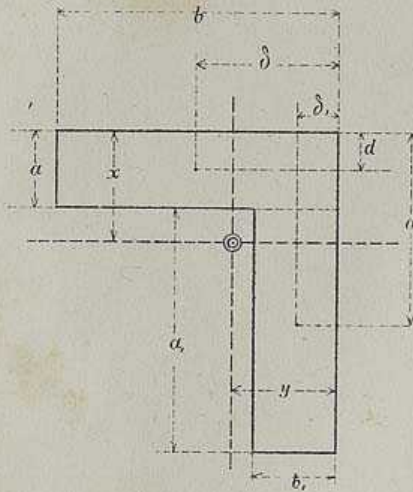

Fig.13

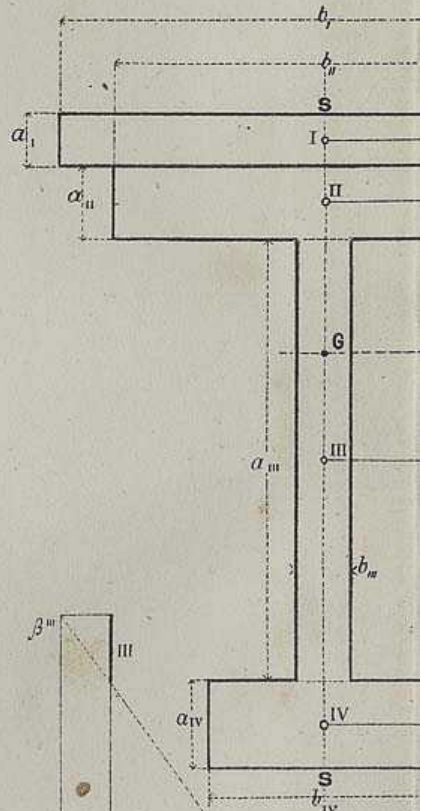

Fig.10

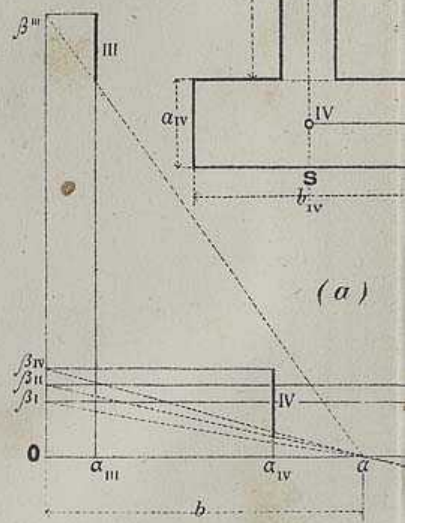
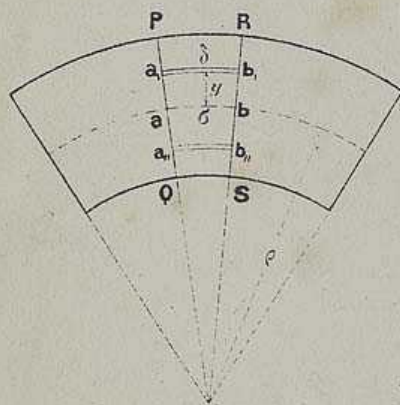
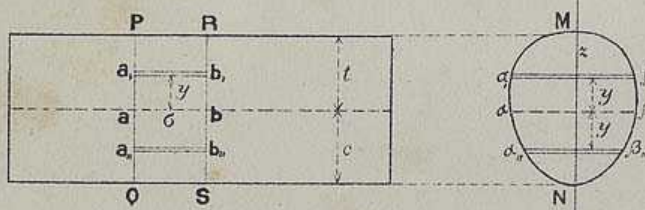



Fig. 4

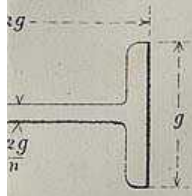

Fig. 5

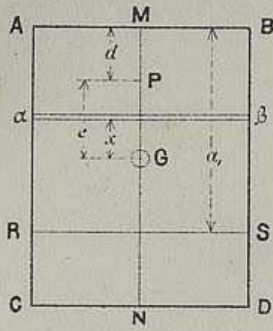

Fig. 8

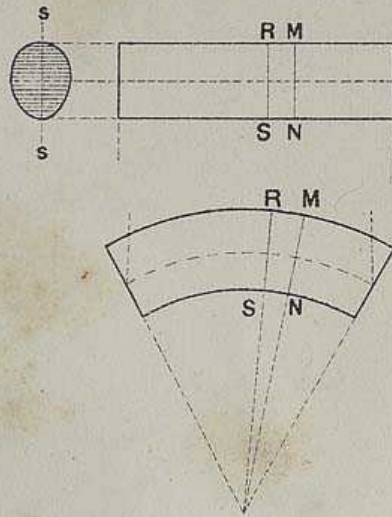

Fig. 7

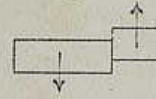

Fig. 9

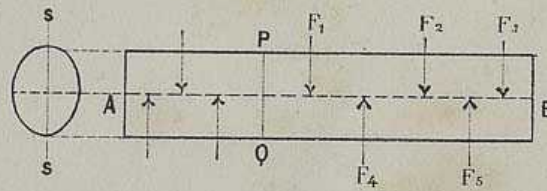

Fig. 12

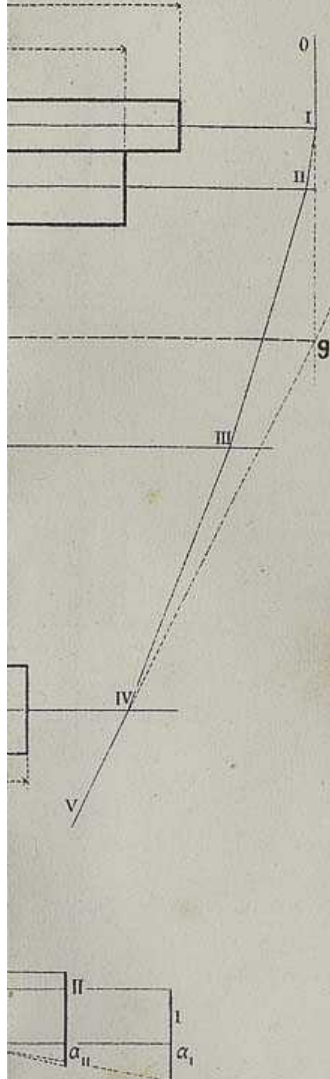
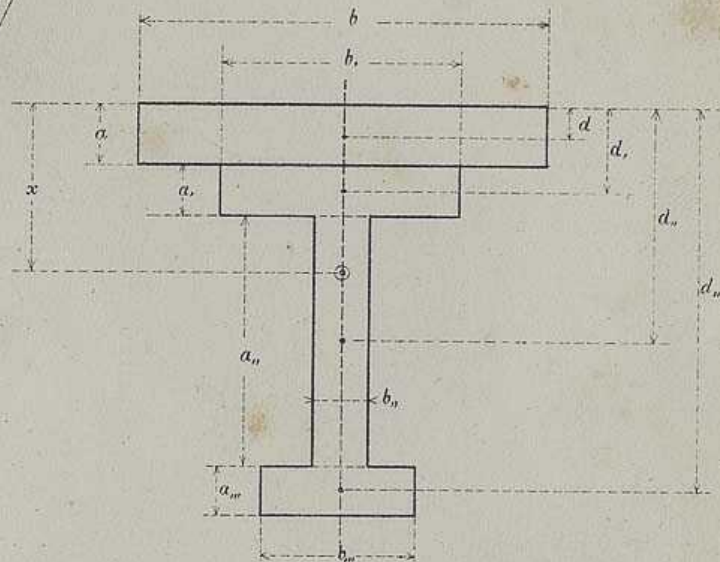



Fig. 14

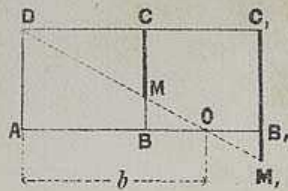

Fig. 15

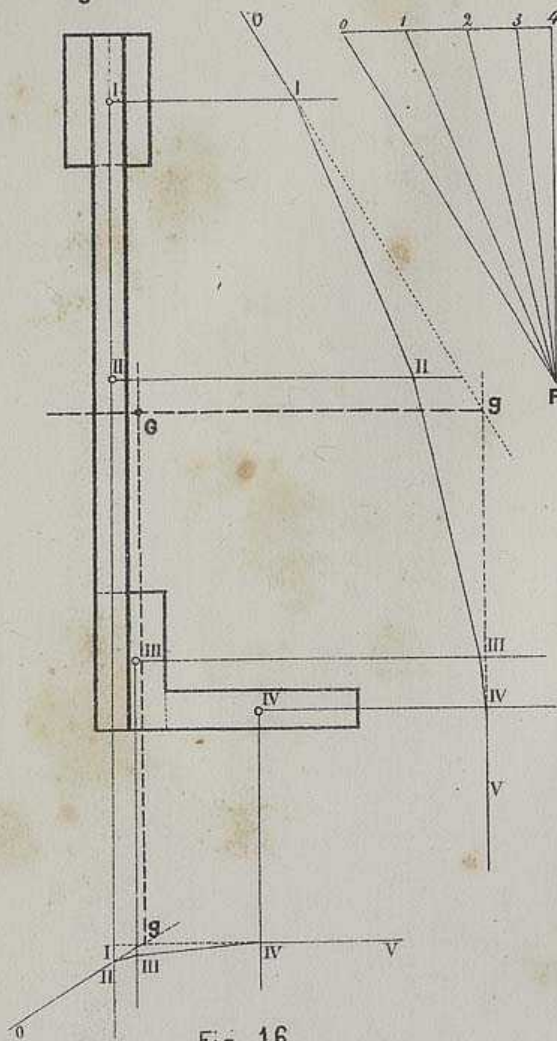

Fig. 16

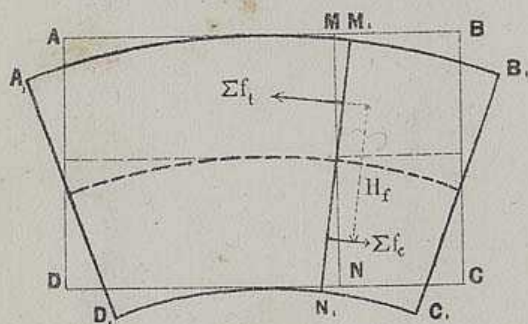

Fig. 17

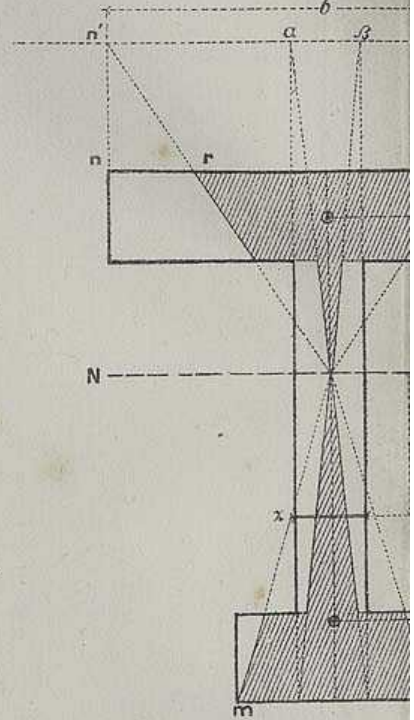

Fig. 18

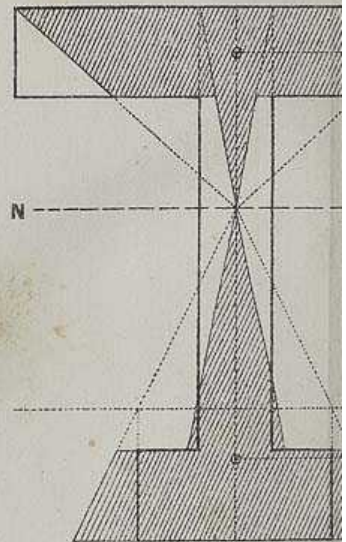

Fig. 20

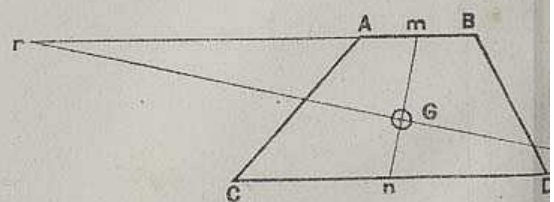



Fig. 19

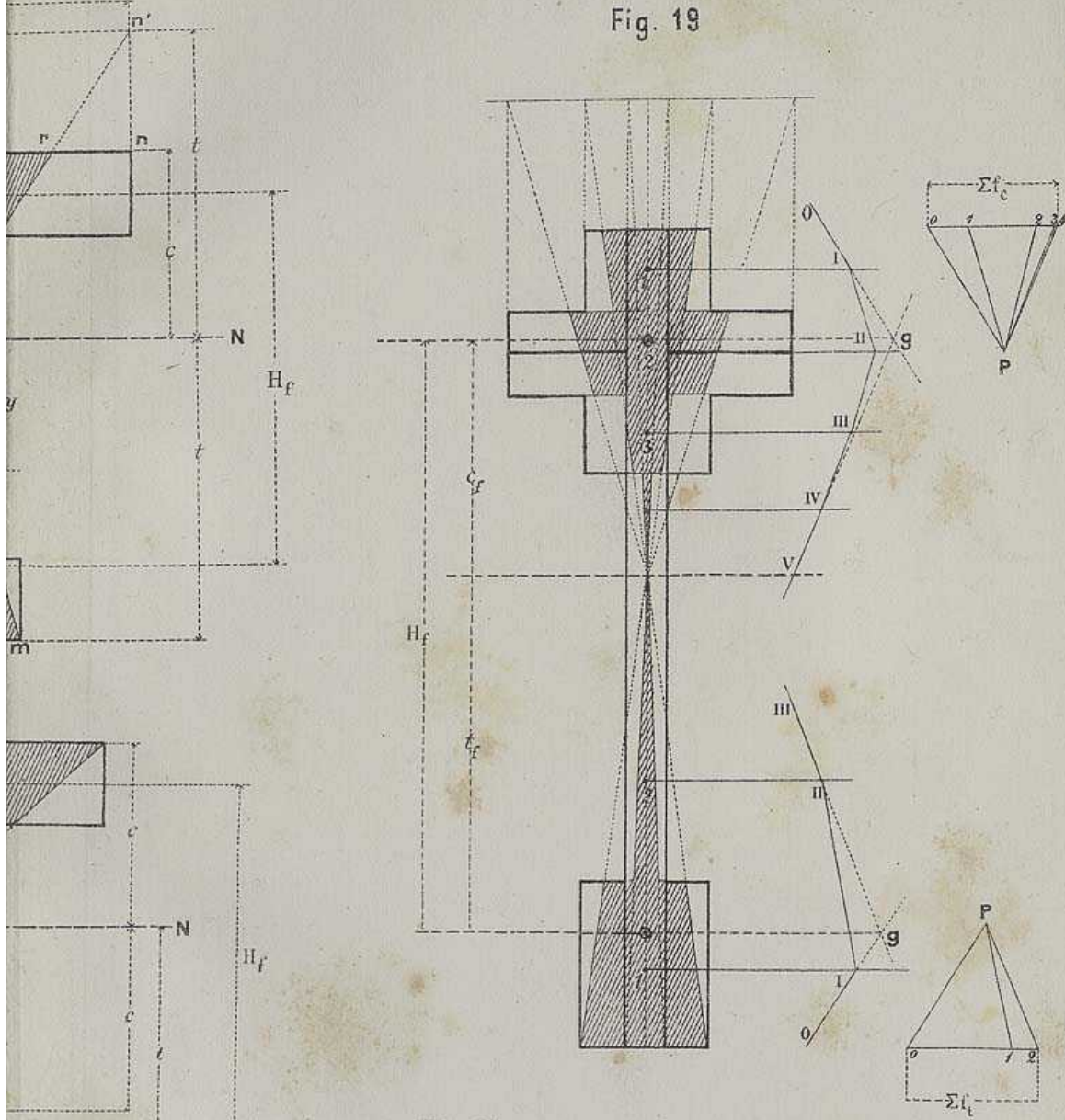

Fig. 21

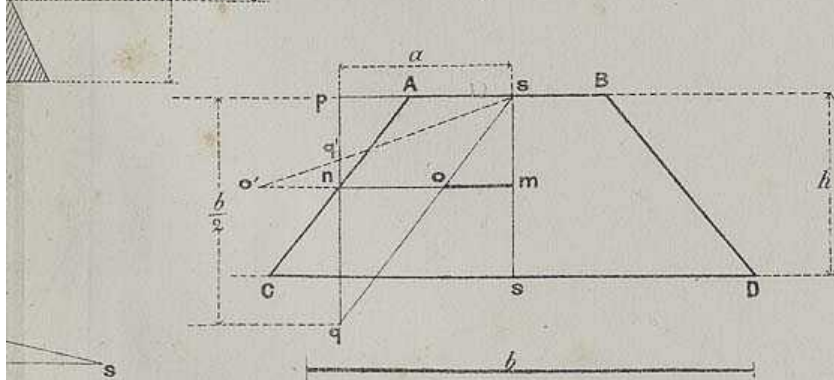

Fig. 22

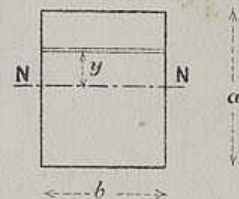



Fig. 23

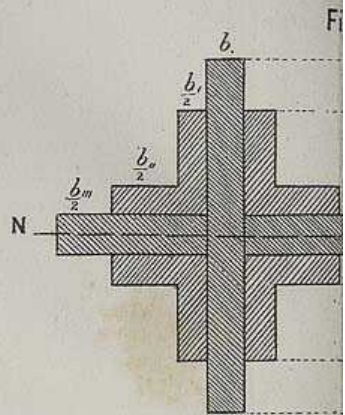
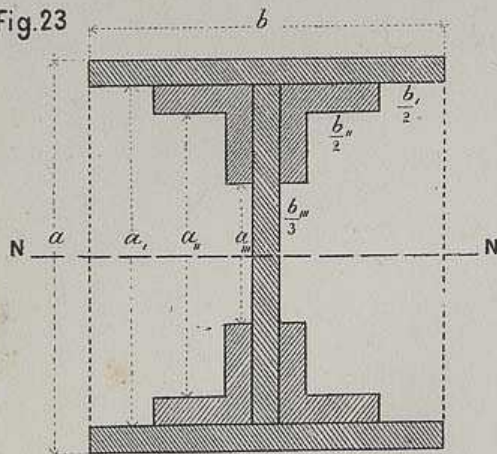

Fig. 26

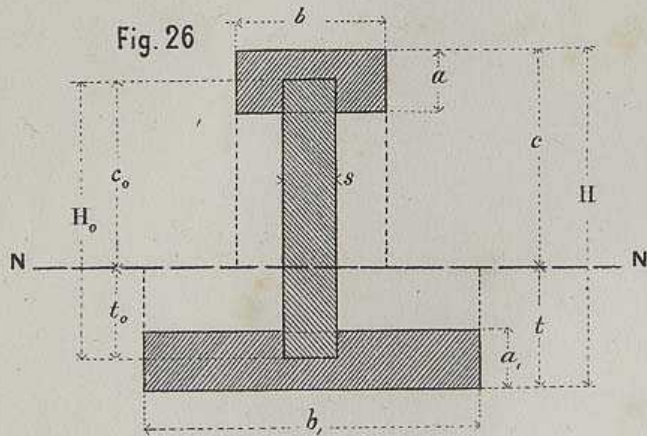

Fig. 27

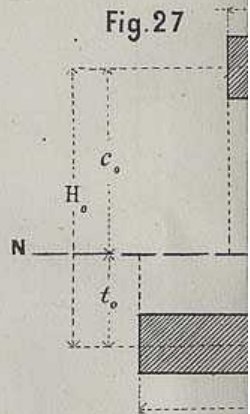

Fig. 28

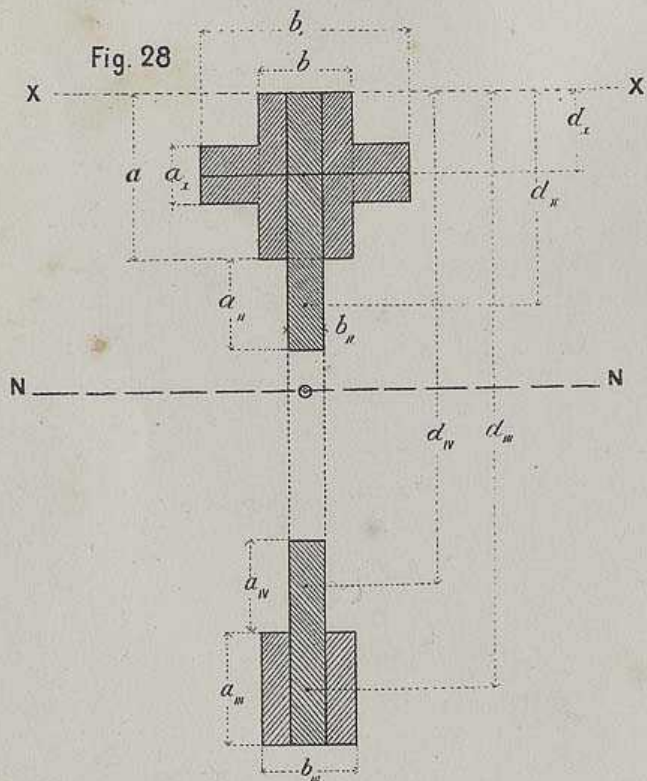

Fig. 29

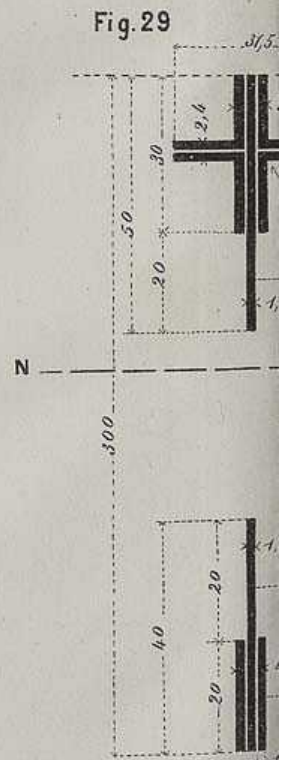



Fig. 24

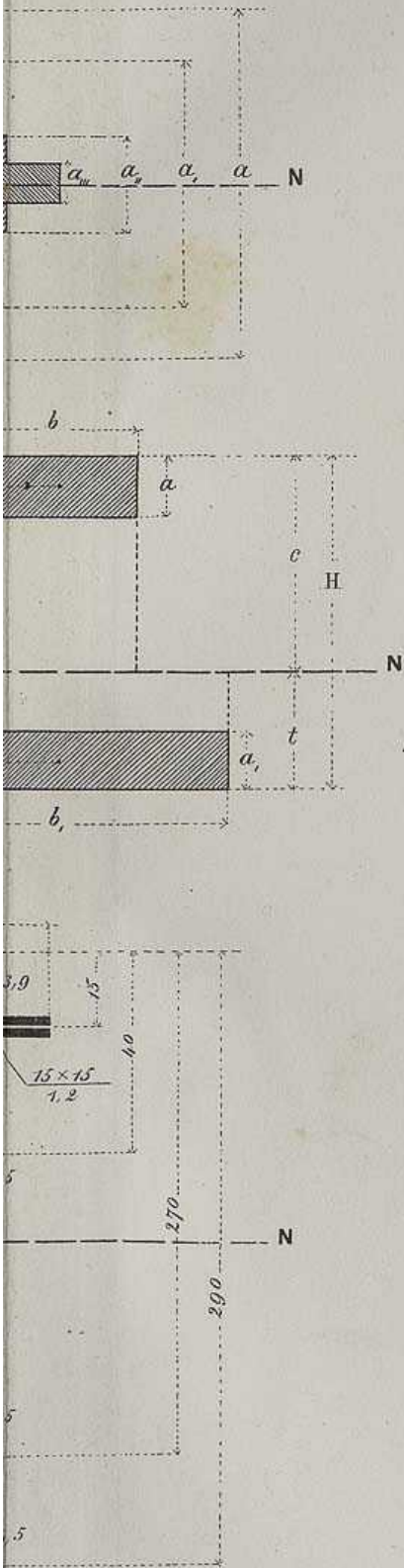

Fig. 25

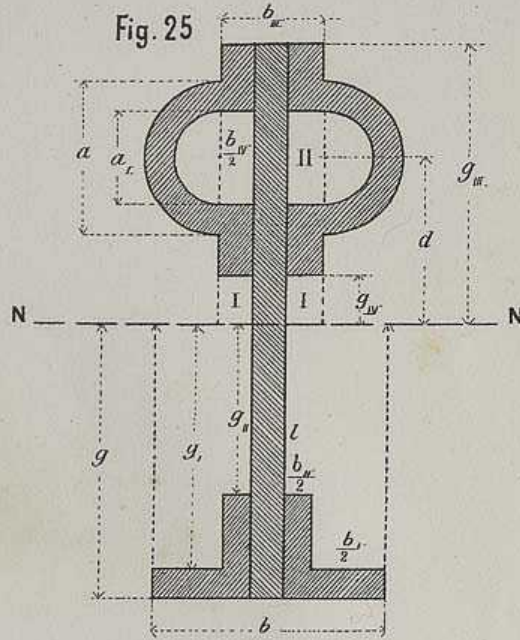

Fig. 30

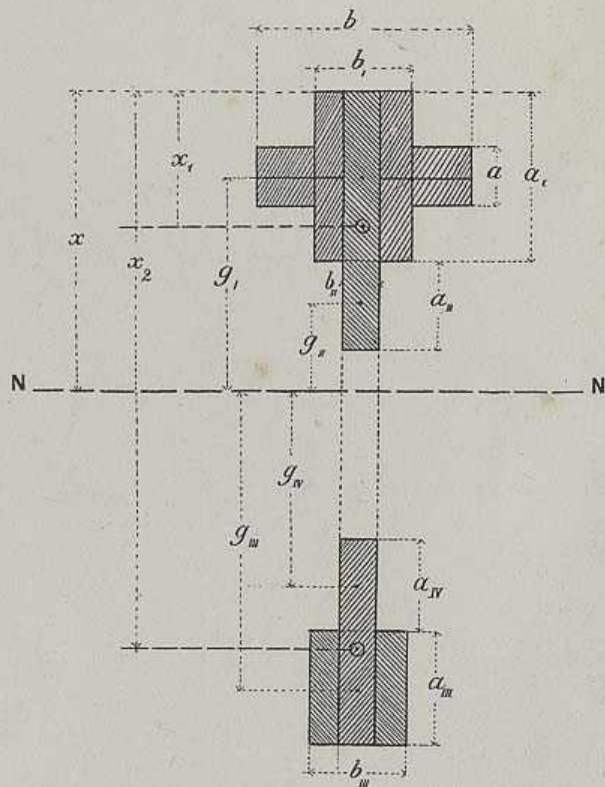







Fig. 32

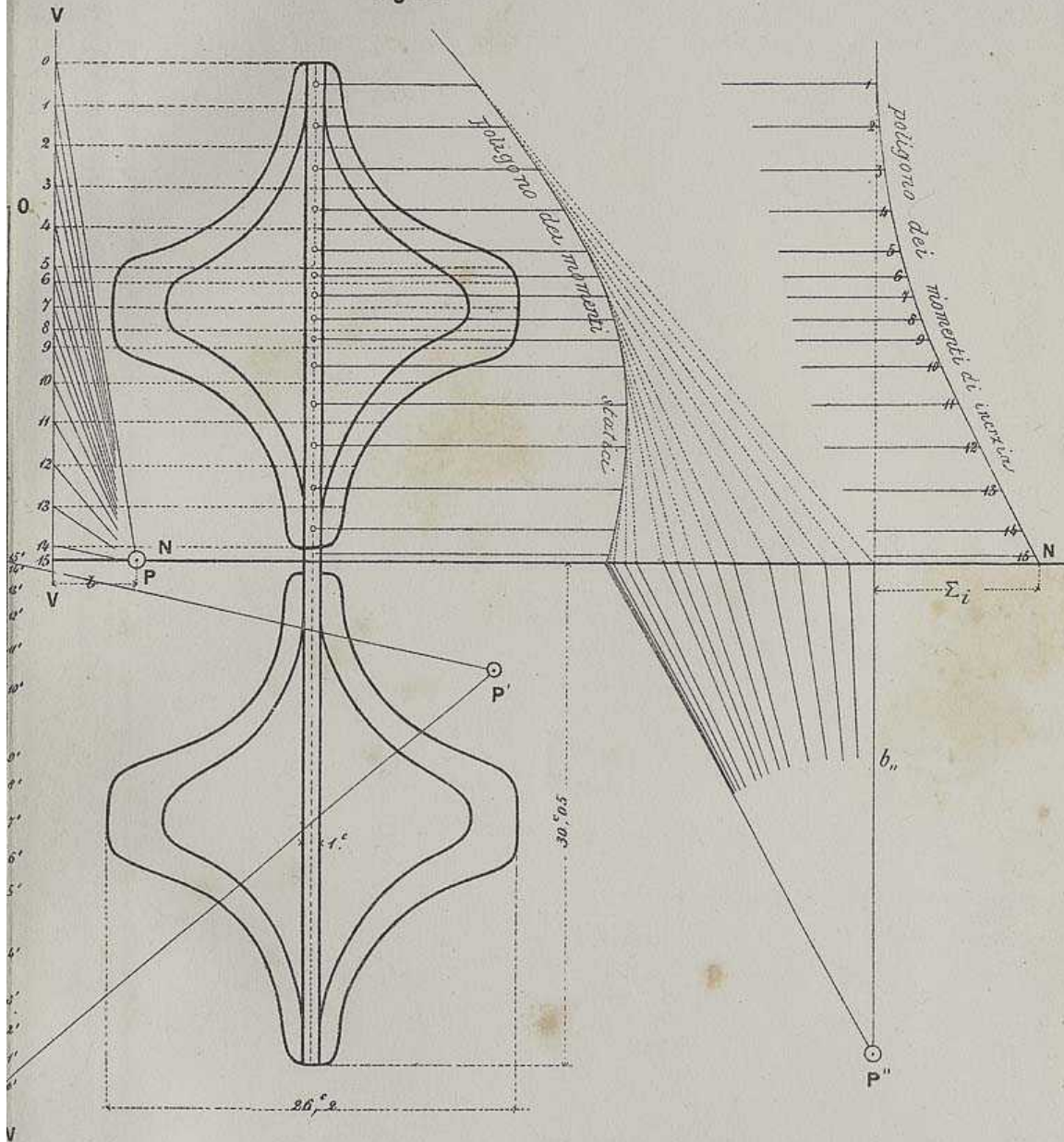

Fig. 37

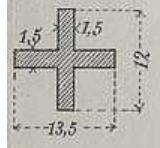

Fig. 38



Fig. 39

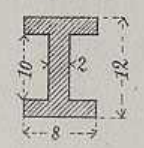

Fig. 38 a

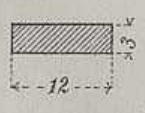

Fig. 39 a

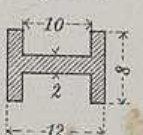

Fig. 40

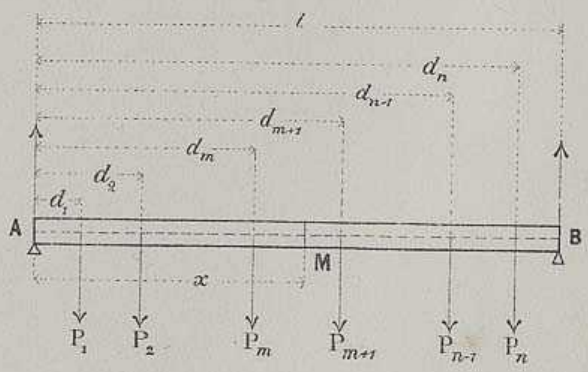



Fig. 41

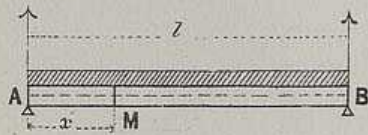

Fig. 42

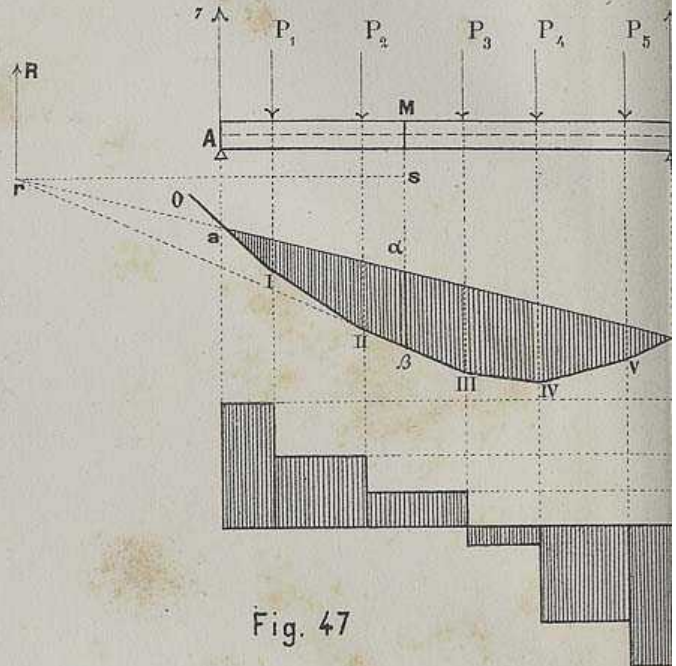

Fig. 44

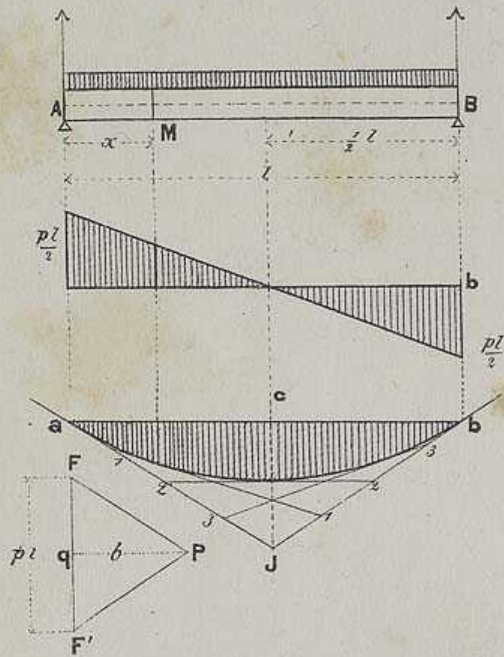

Fig. 47

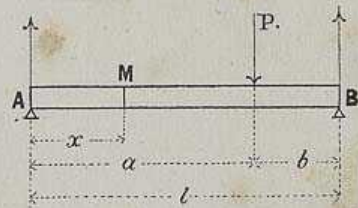

Fig. 49

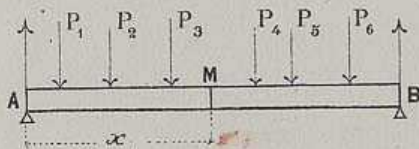

Fig. 50

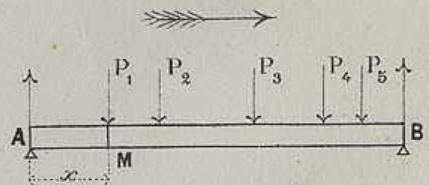

Fig. 52

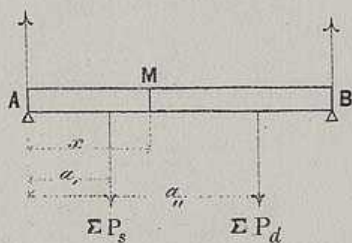

Fig. 53

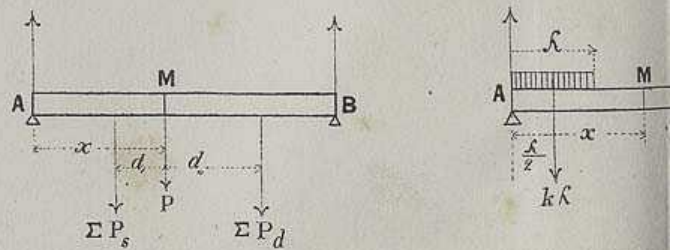



Fig. 43

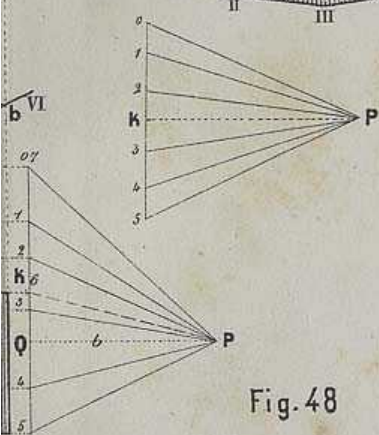
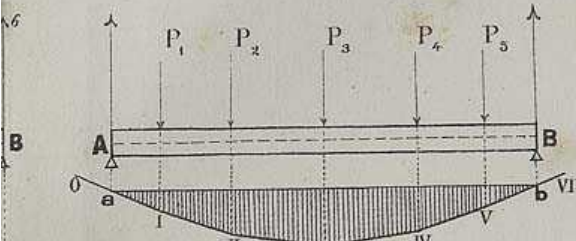

Fig. 48

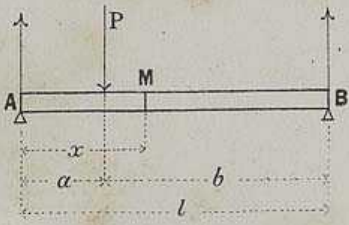

Fig. 51

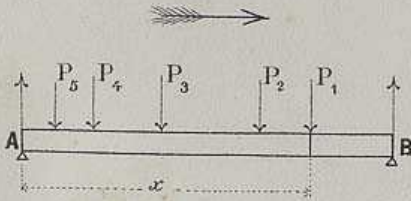

Fig. 54

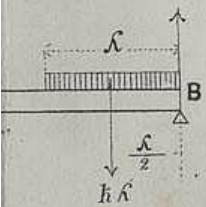

Fig. 56

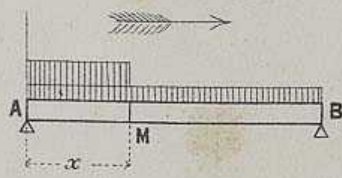

Fig. 57

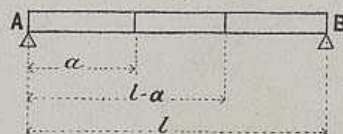

Fig. 45

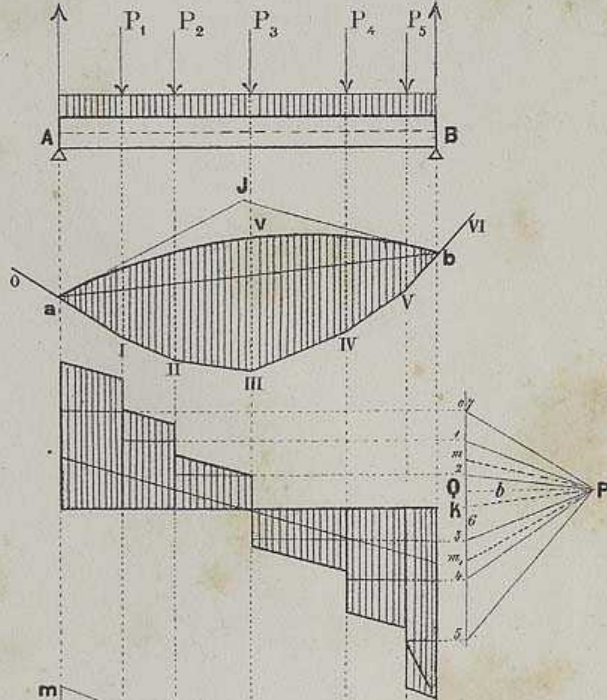

Fig. 46

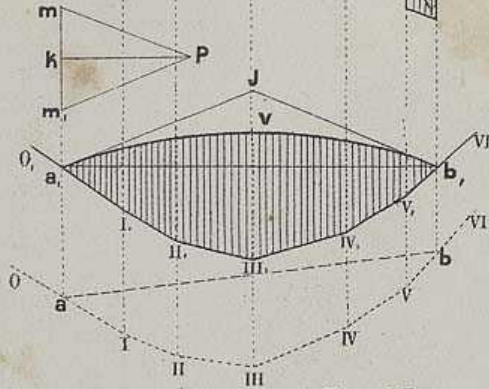

Fig. 55

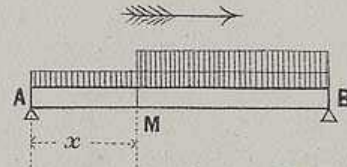



Fig. 58

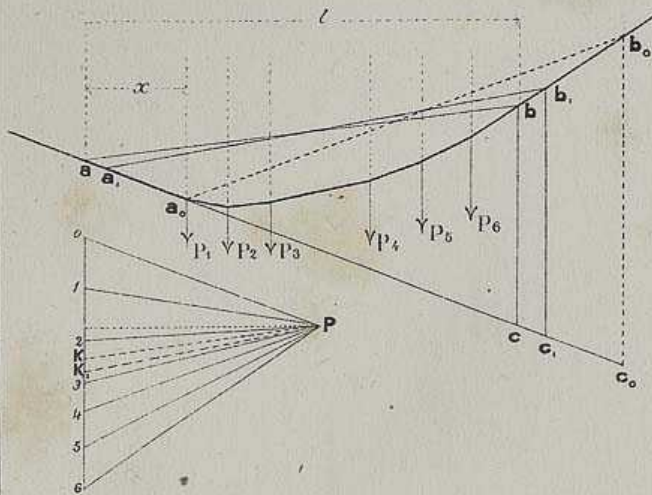

Fig. 59

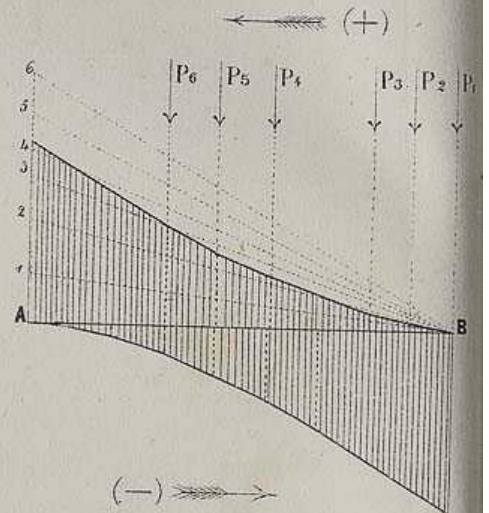

Fig. 61

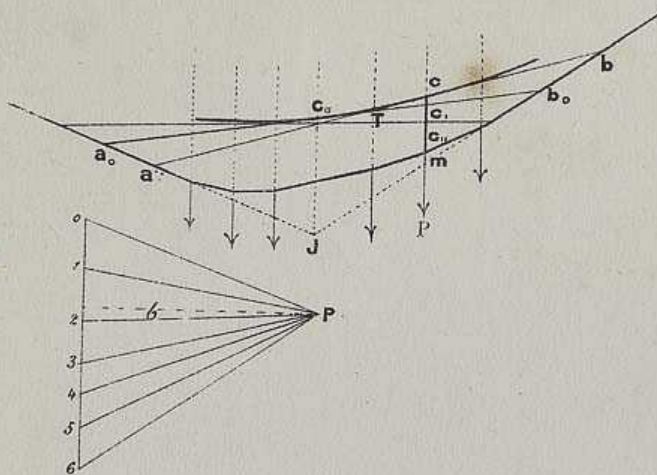

Fig. 62

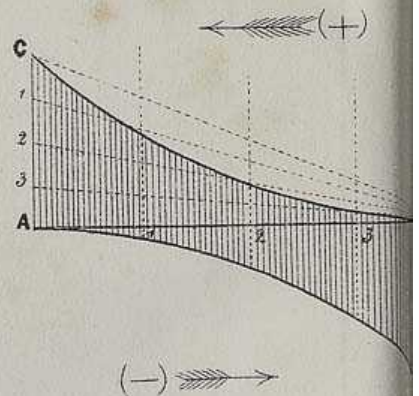

Fig. 67

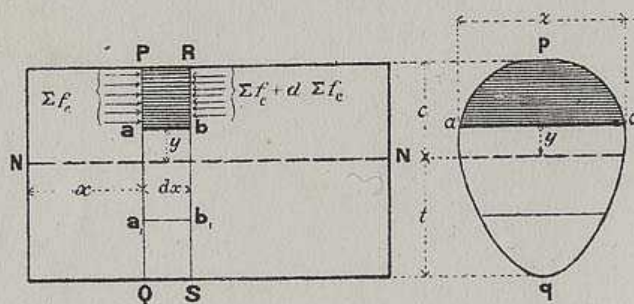

Fig. 68





Fig. 60

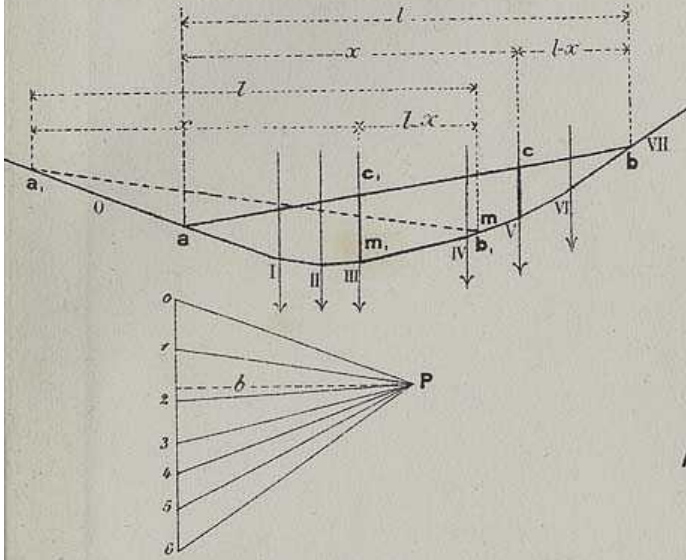

Fig. 65

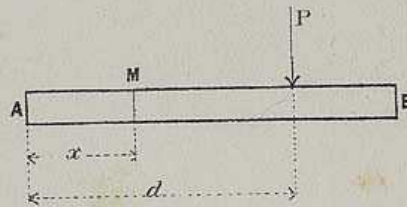

Fig. 64

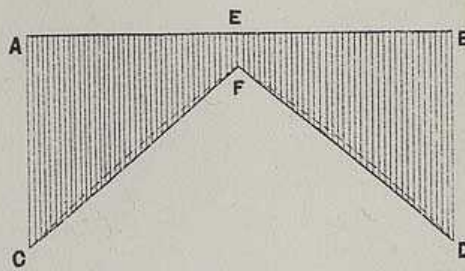

Fig. 63

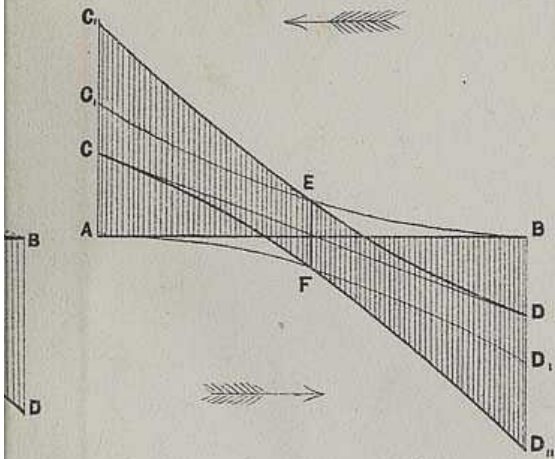

Fig. 66

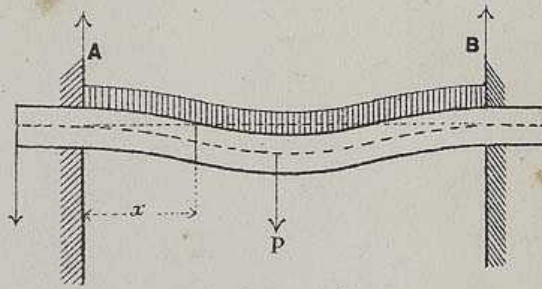

Fig. 69

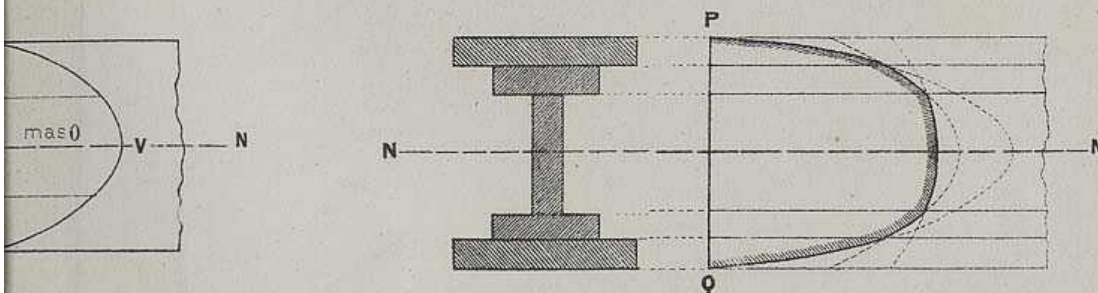











Fig. 80

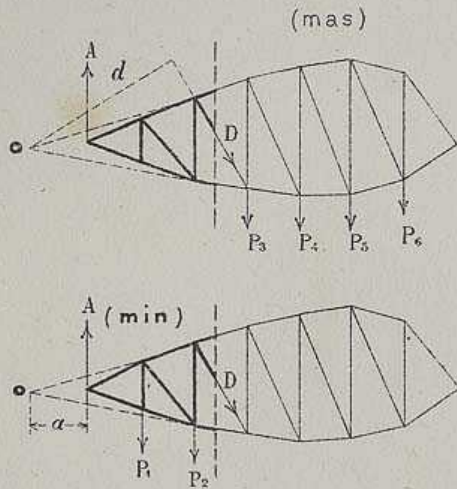

Fig. 81

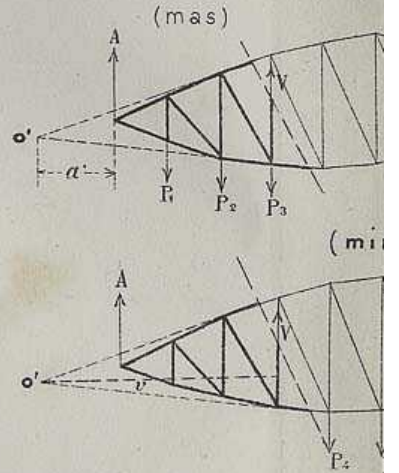

Fig. 83

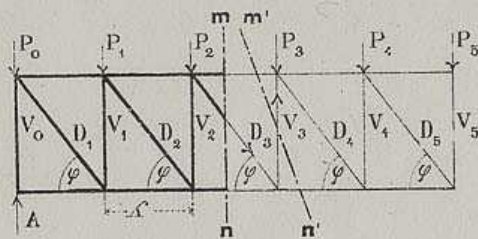

Fig. 84

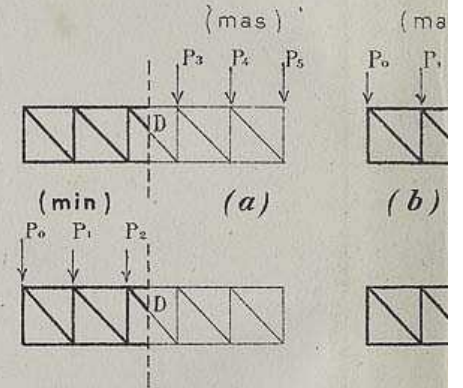

Fig. 85

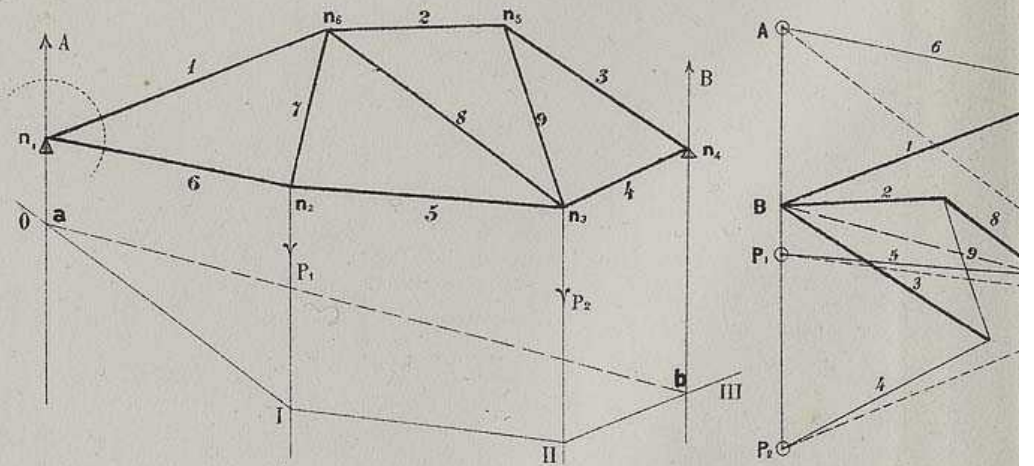



Fig. 82

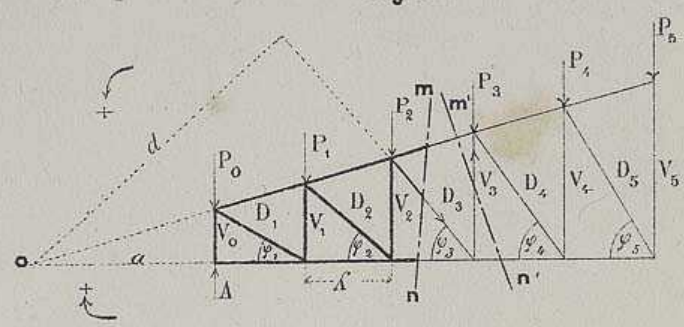

Fig. 86

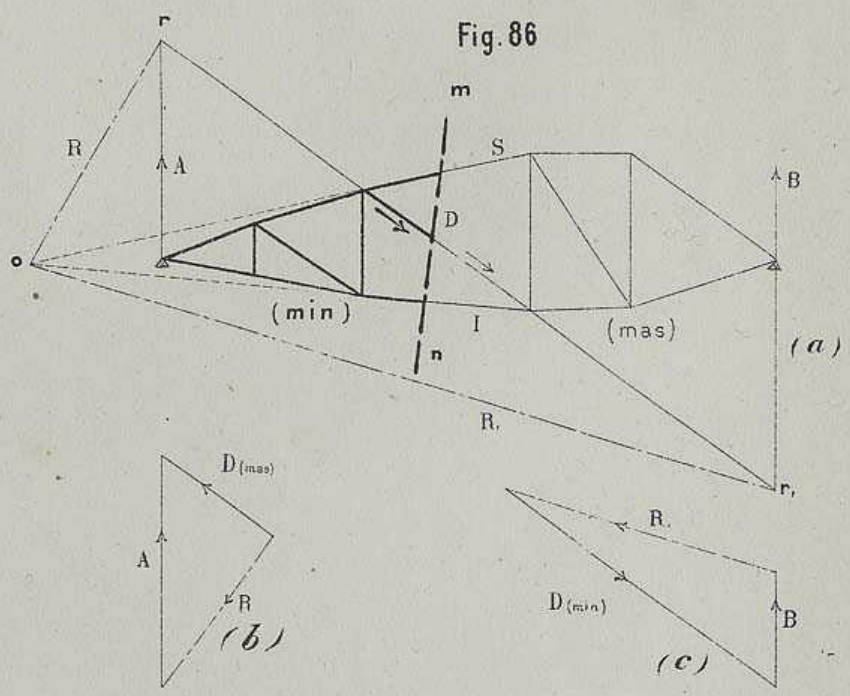

Fig. 87

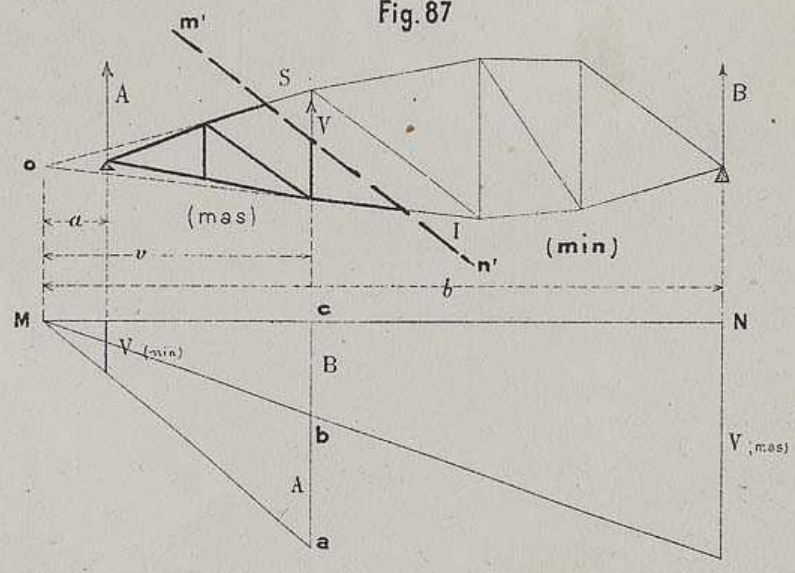



Fig. 88

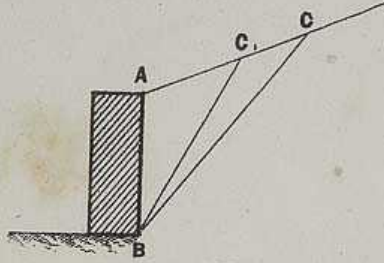

Fig. 89

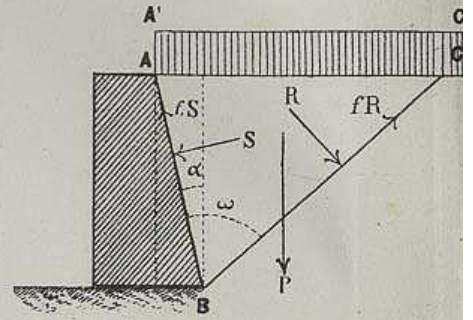

Fig. 93

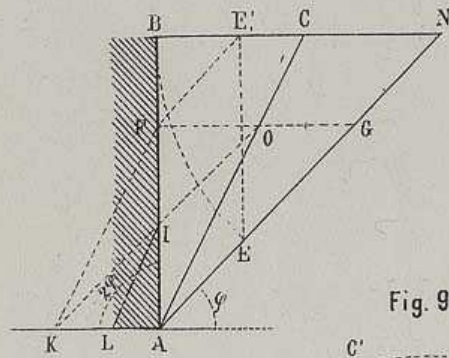

Fig. 90

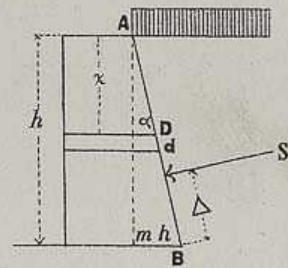

Fig. 91

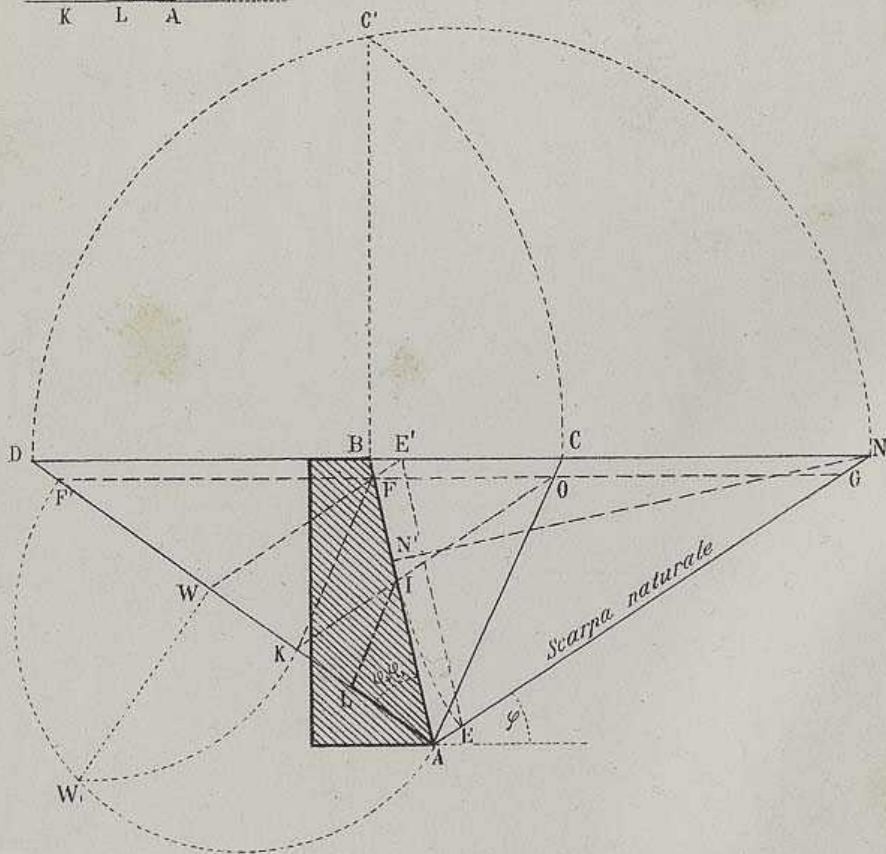
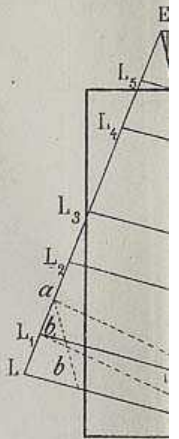

Fig.





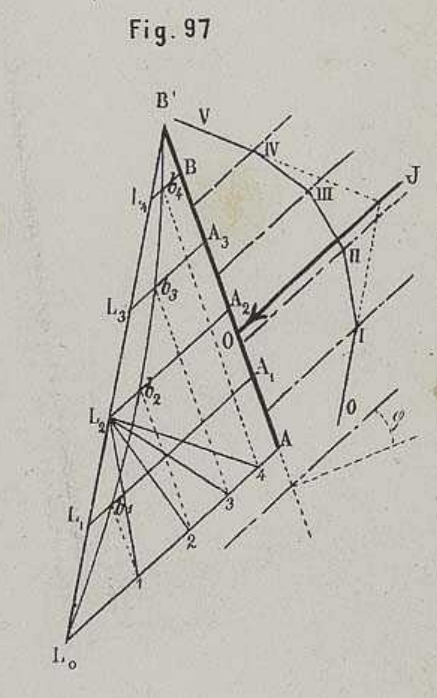
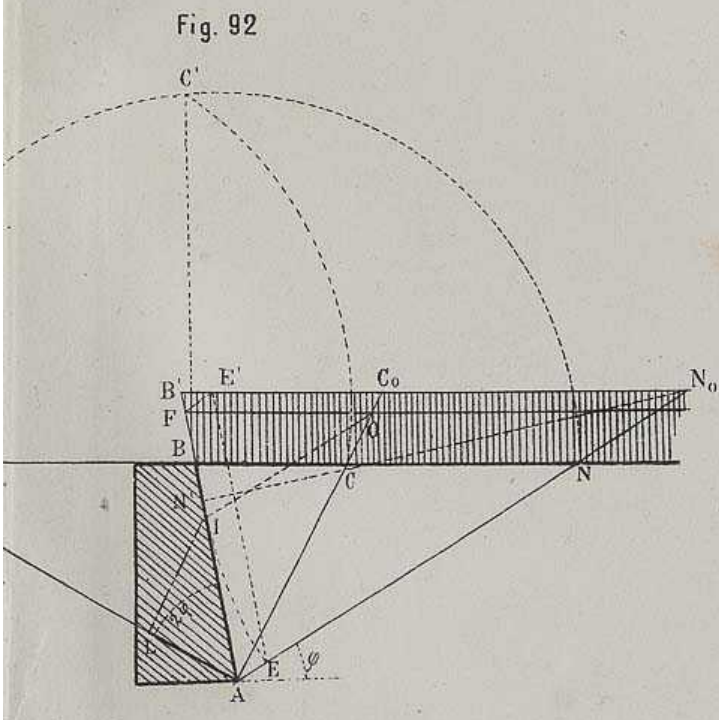
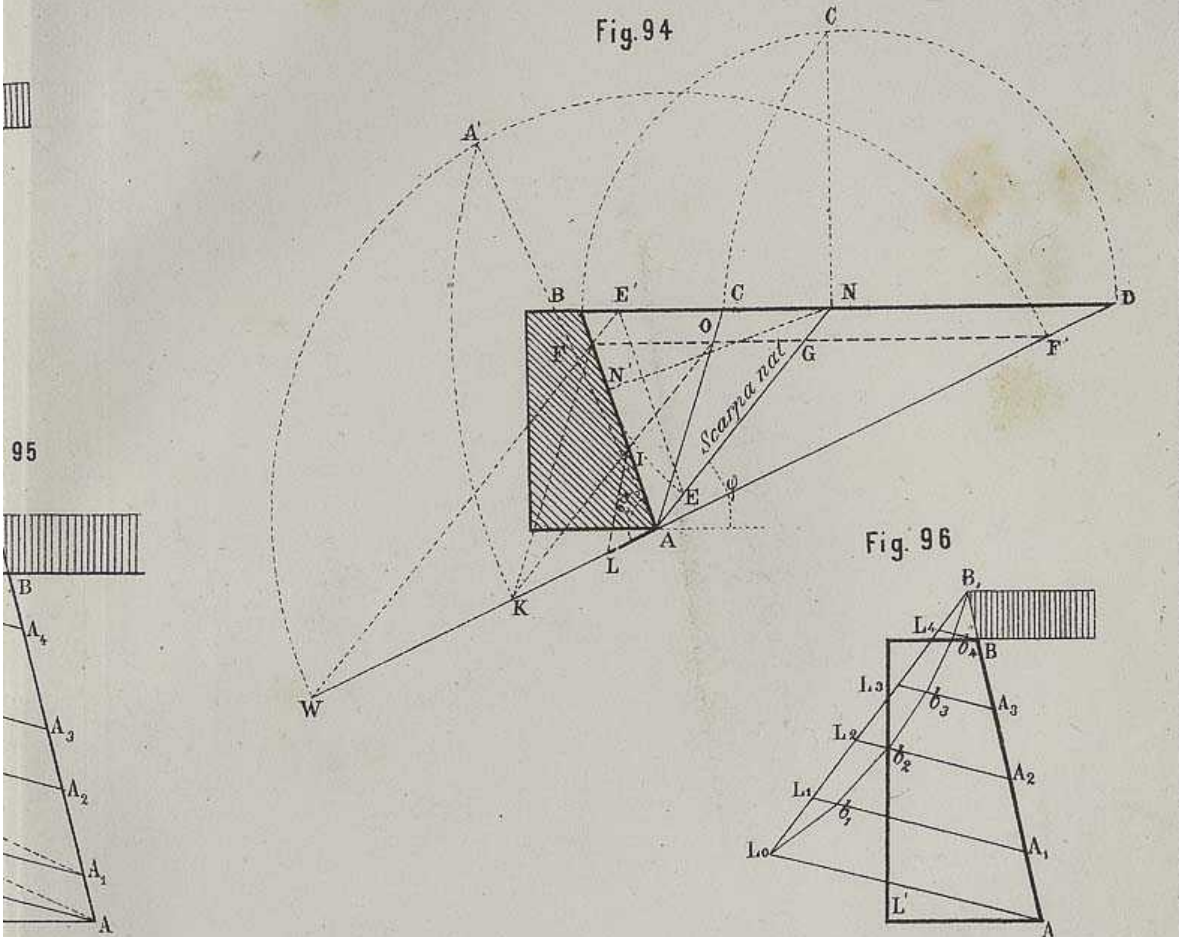



Fig. 98

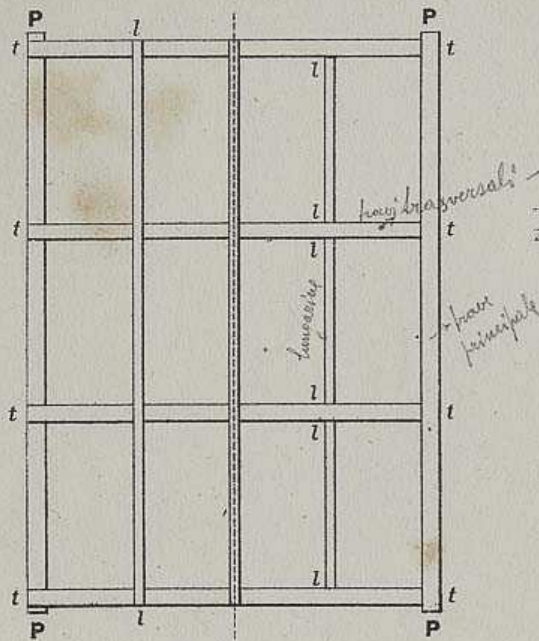

Fig. 99

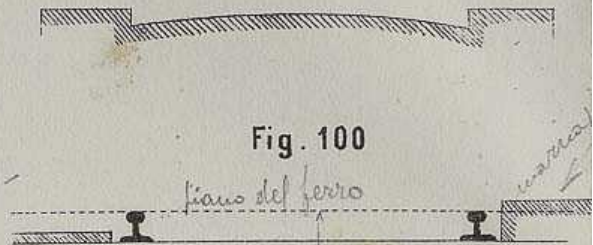

Fig. 100

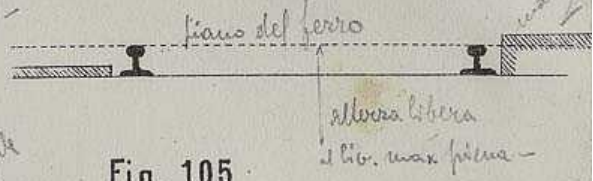

Fig. 105

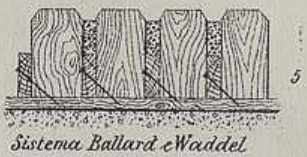

Fig. 106

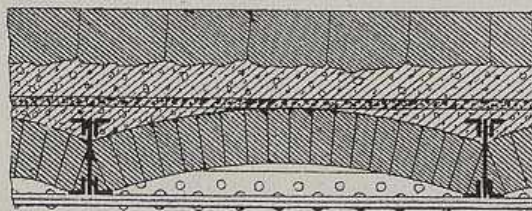

Fig. 1

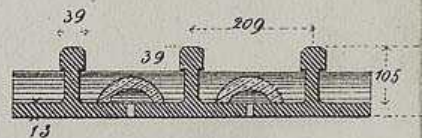

Fig. 107

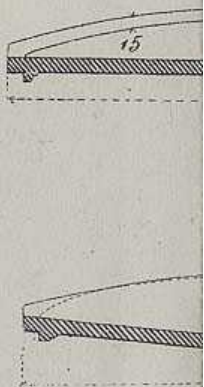
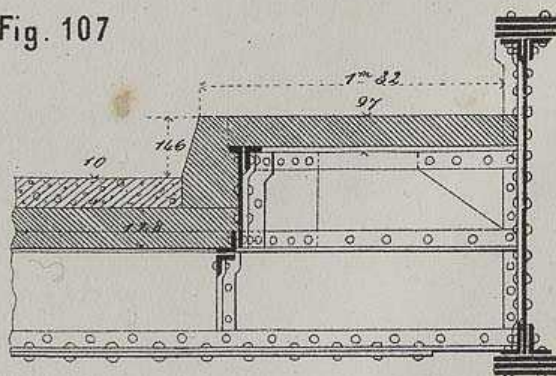
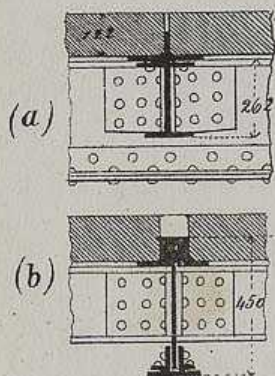



Fig 102

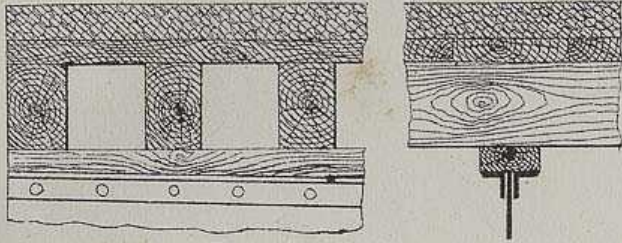

Fig. 101

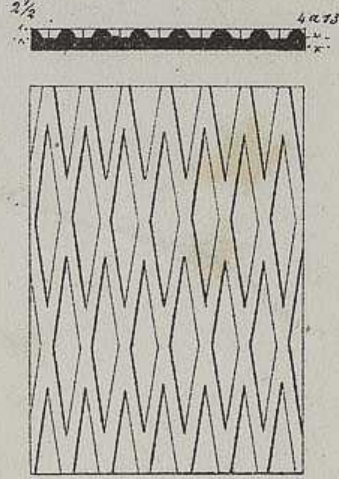

Fig. 103

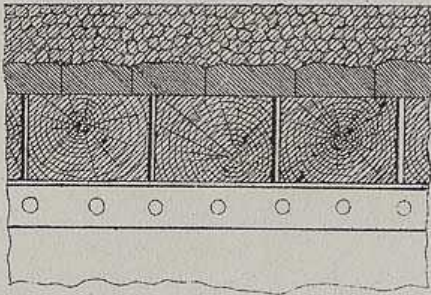
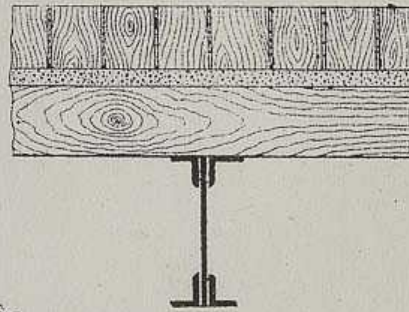

Fig. 104



08

Fig. 111

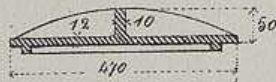
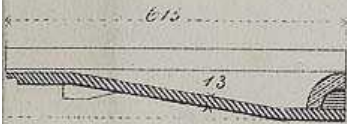

Fig. 112

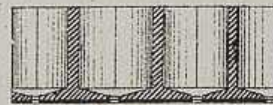

Fig. 109

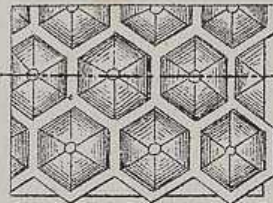
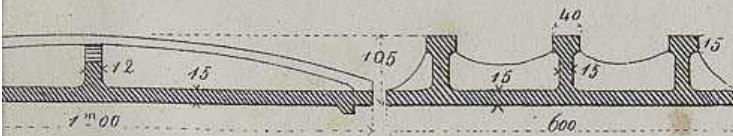

Fig. 110

Fig. 113

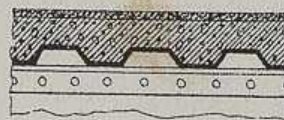
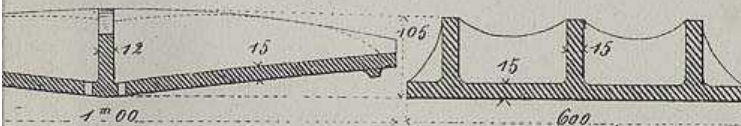



Fig. 114

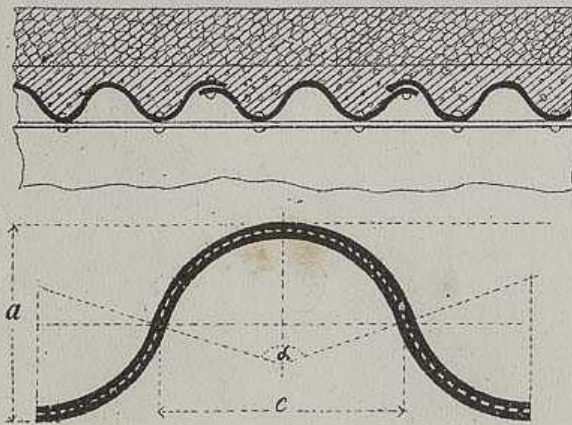

Fig. 121

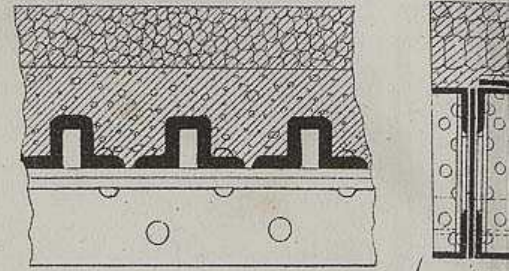

Fig. 117

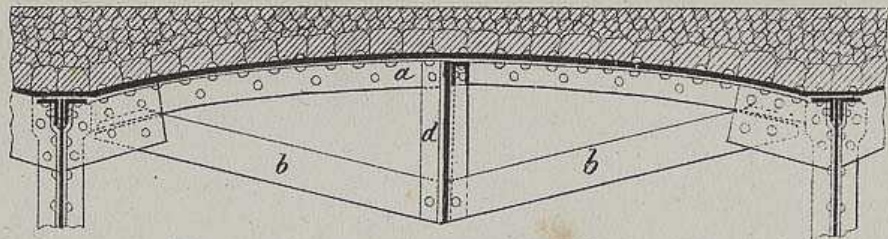

Fig. 116

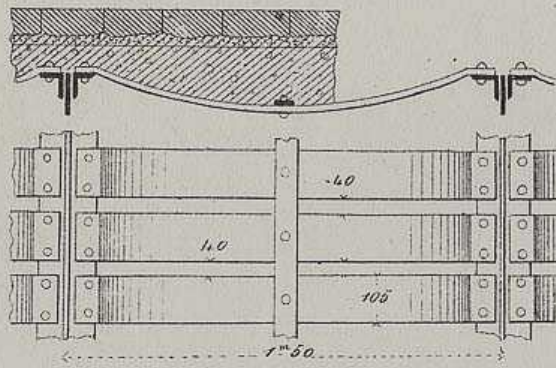

Fig. 118

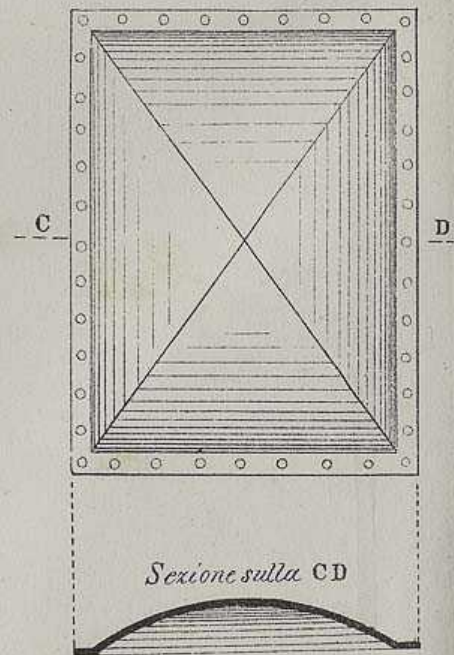
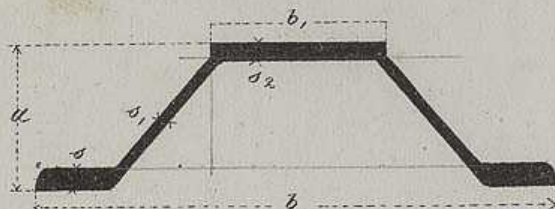

Fig. 124



*mezzana  
d'una lamiera*



Fig. 115

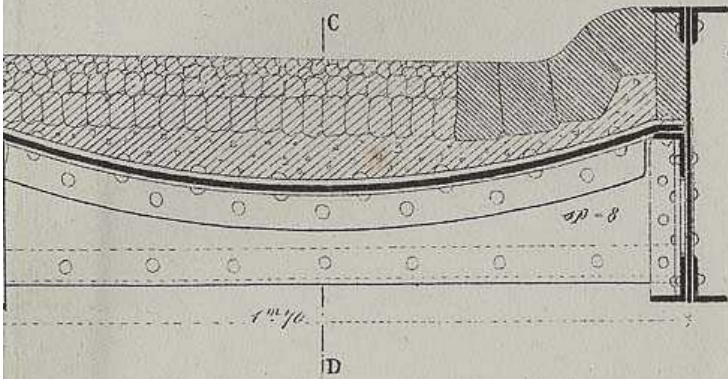

Sezione sulla CD

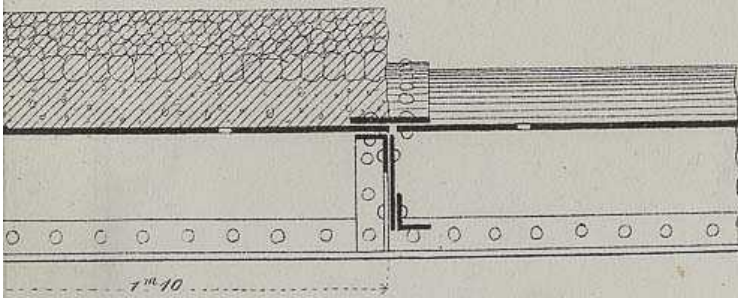

Fig. 119

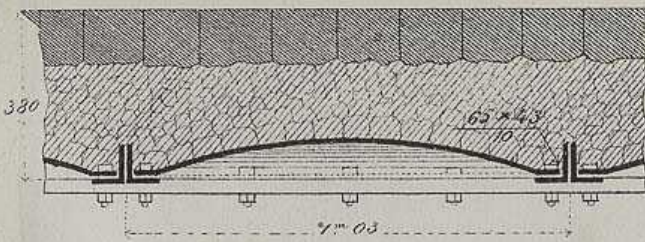

Fig. 125

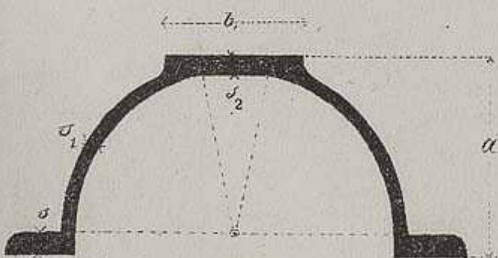

Fig. 120

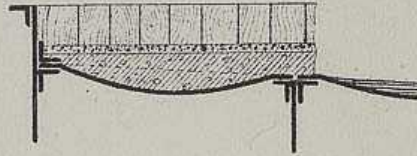

Fig. 122

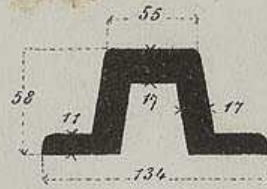

Fig. 123

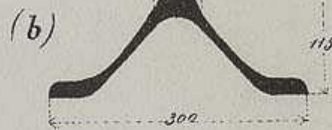
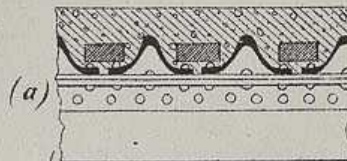

Fig. 126





Fig. 127

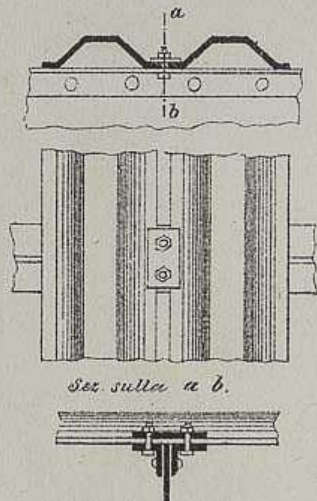

Fig. 128

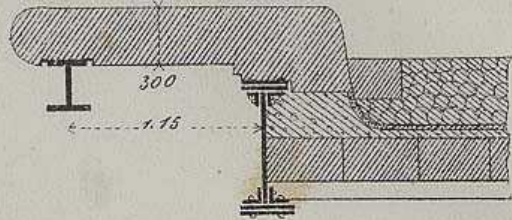

Fig. 129

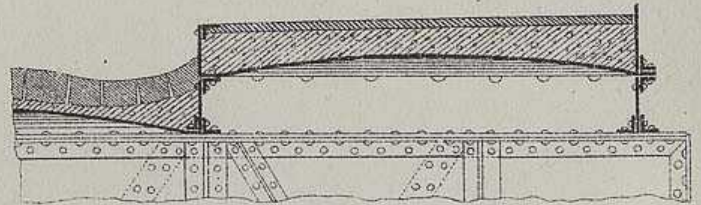

Fig. 132

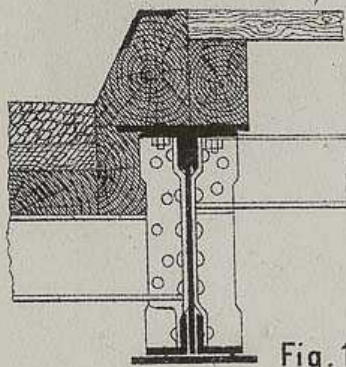

Fig. 133

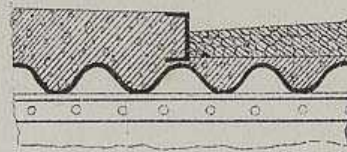

Fig. 135

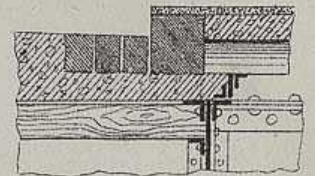

Fig. 137

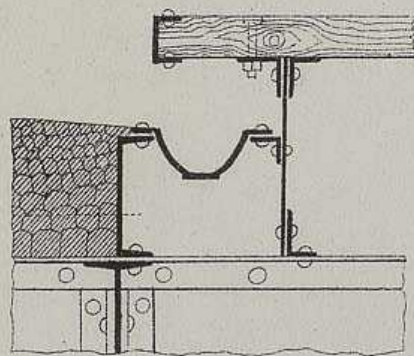

Fig. 138

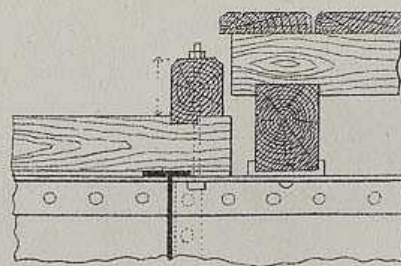
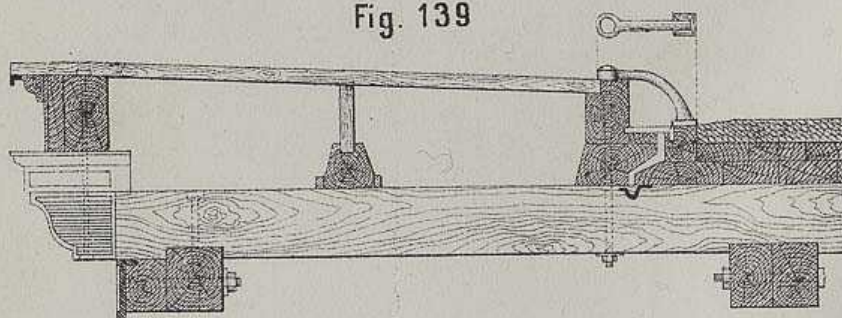

Fig. 139



Fig

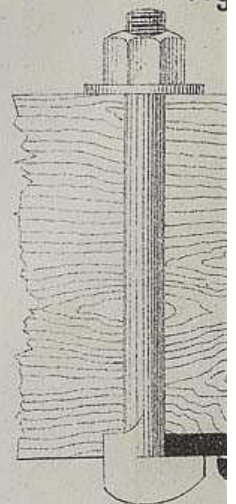



Fig. 131

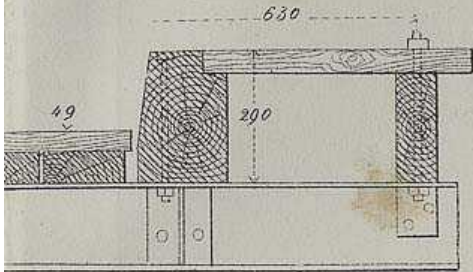

Fig. 136

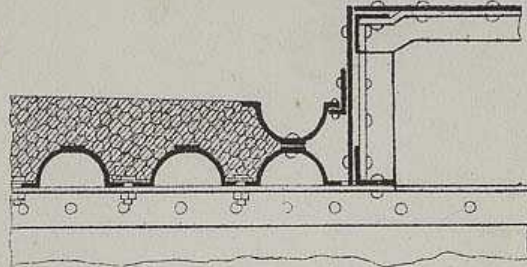

Fig. 130

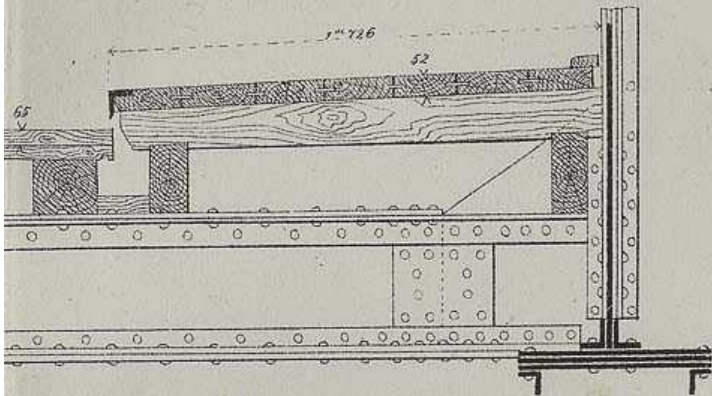

Fig. 144

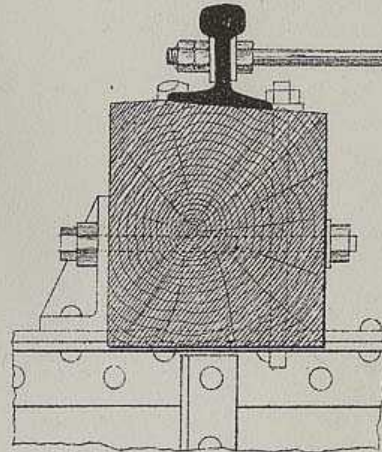

Fig. 134

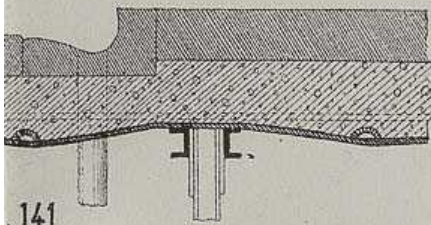

Fig. 143

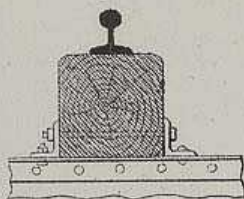

Fig. 142

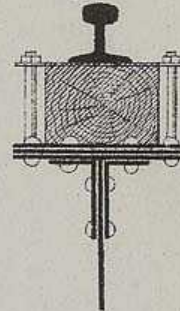

Fig. 140



Fig. 145

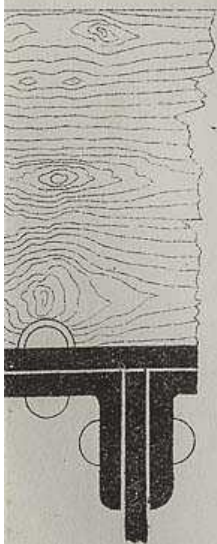
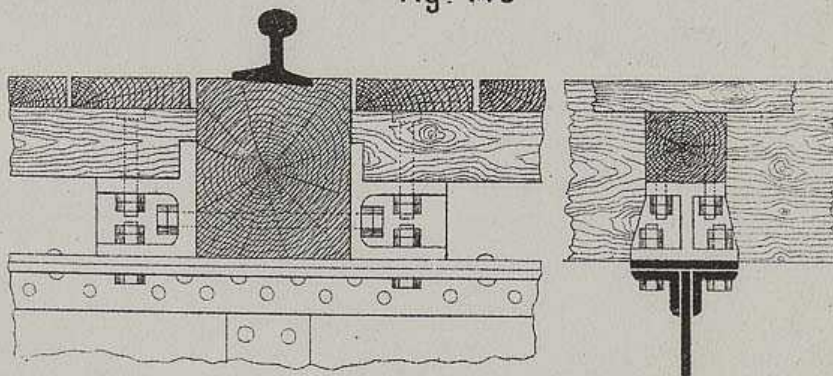



Fig. 146

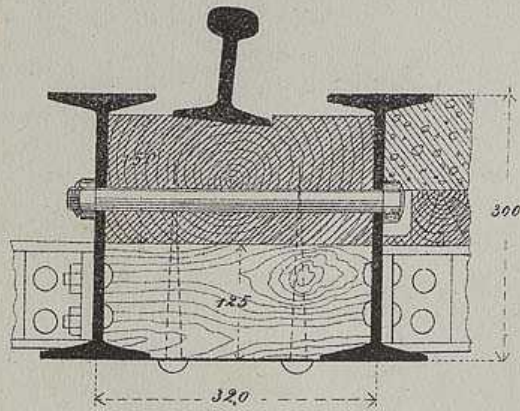

Fig. 148

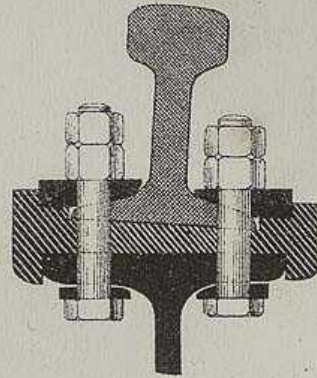

Fig. 149

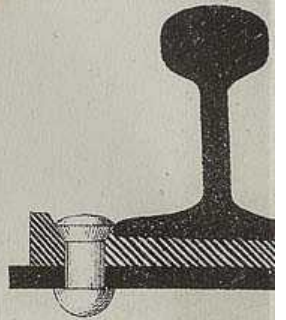

Fig. 147

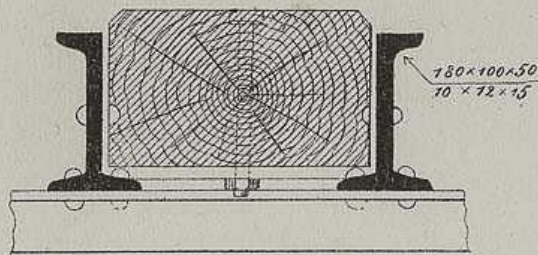

Fig. 151

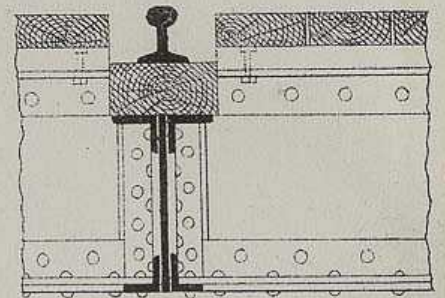

Fig. 153

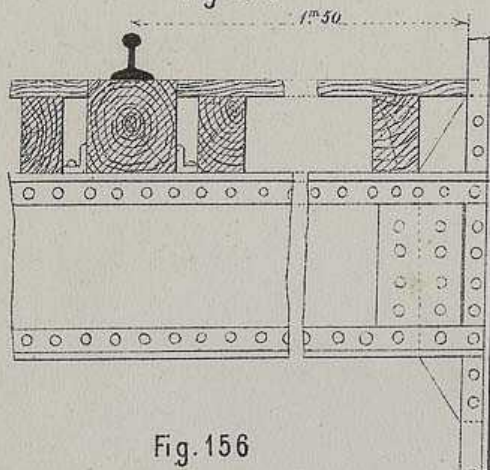

Fig. 157

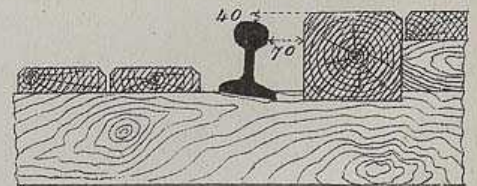

Fig. 156

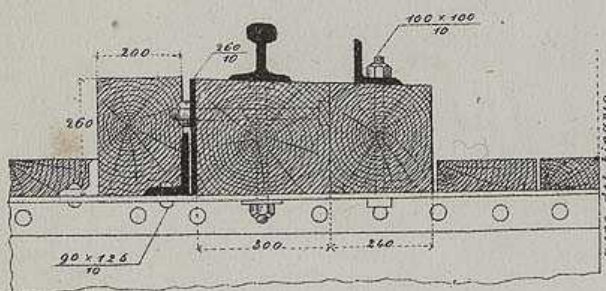

Fig. 159

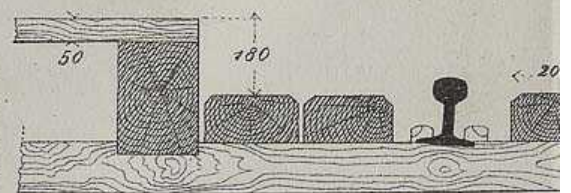



Fig. 150

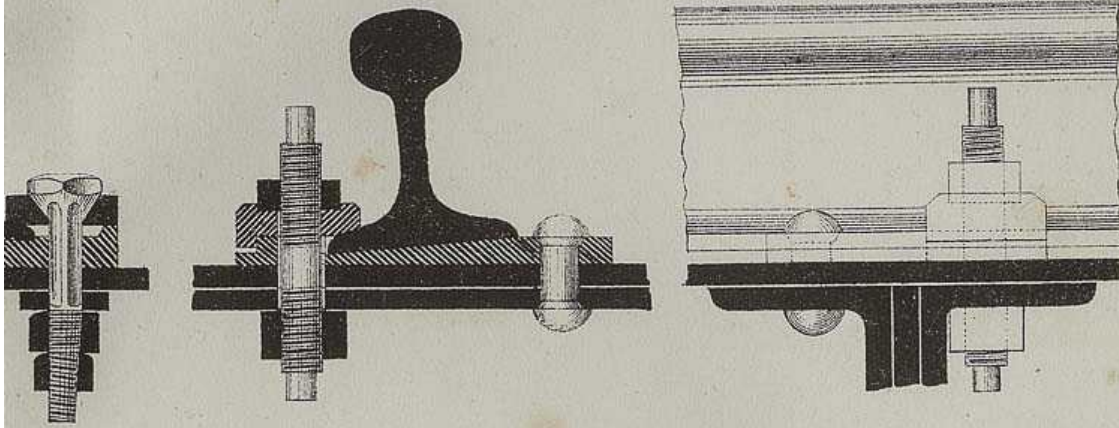

Fig. 152



Fig. 154

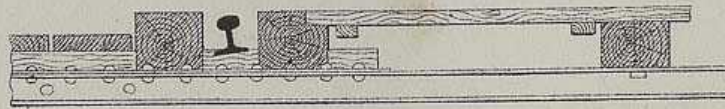

Fig. 155

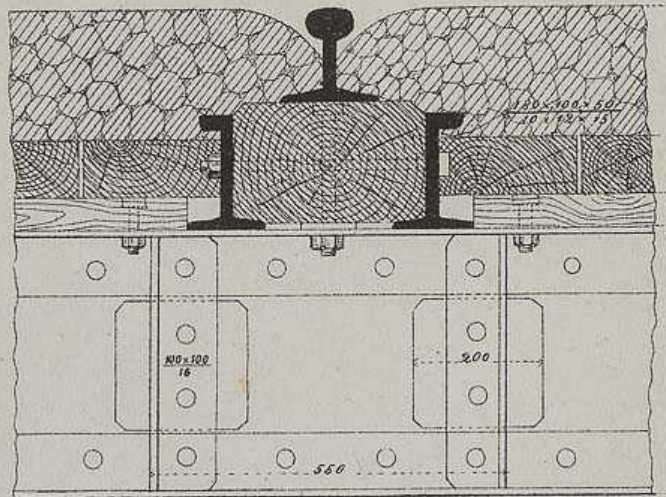

Fig. 158

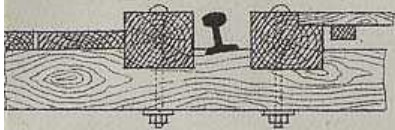

Fig. 160

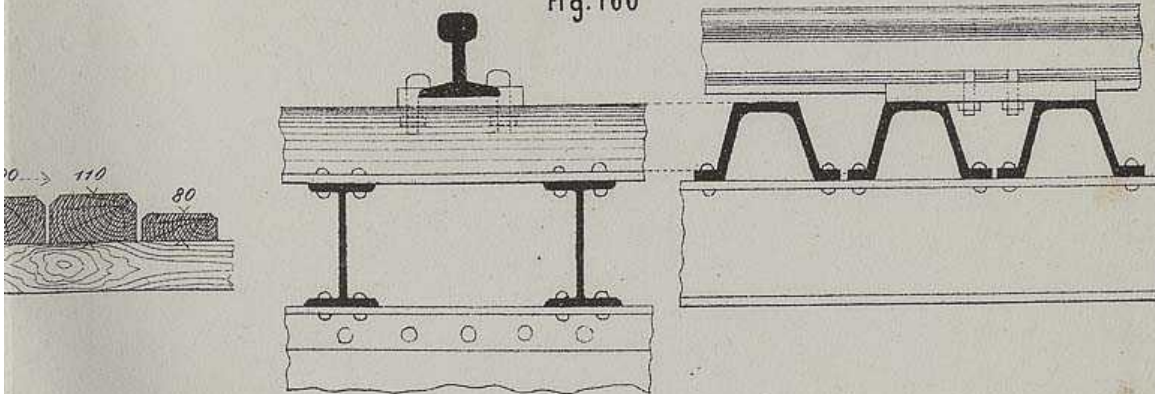



Fig. 161

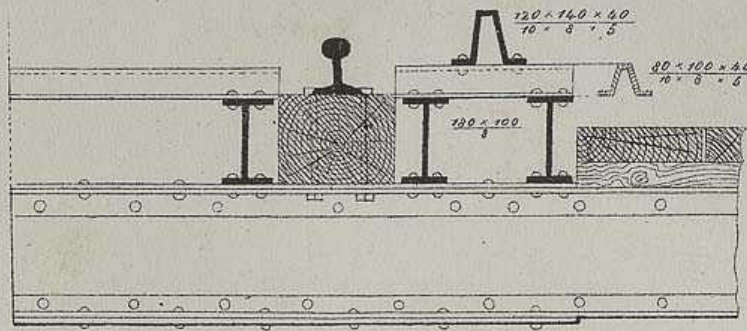

Fig. 163

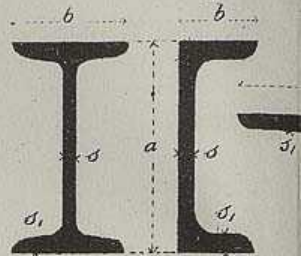

Fig. 162

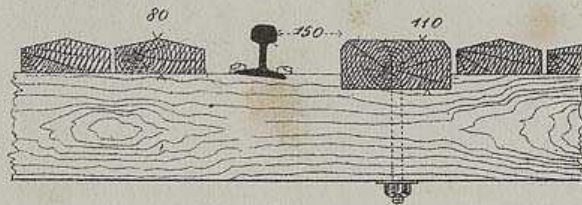

Fig. 166

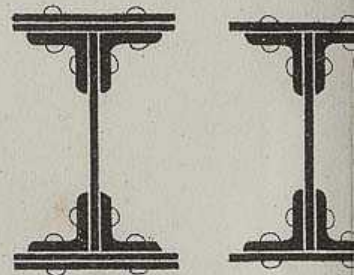

Fig. 168

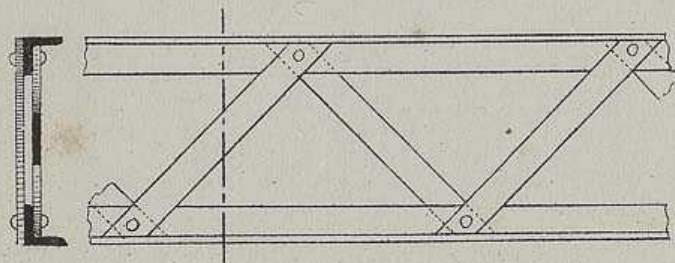

Fig.

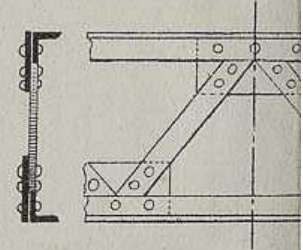

Fig. 171

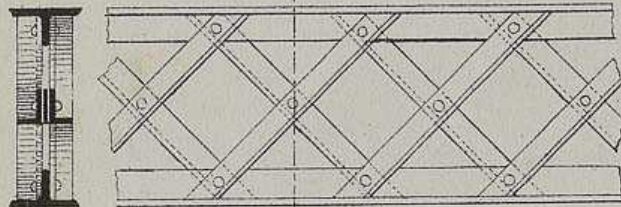

Fig. 172

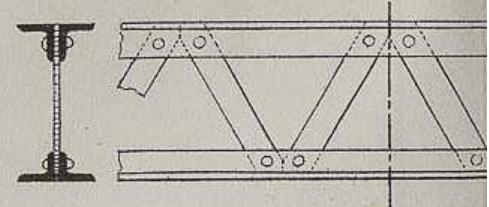

Fig. 174

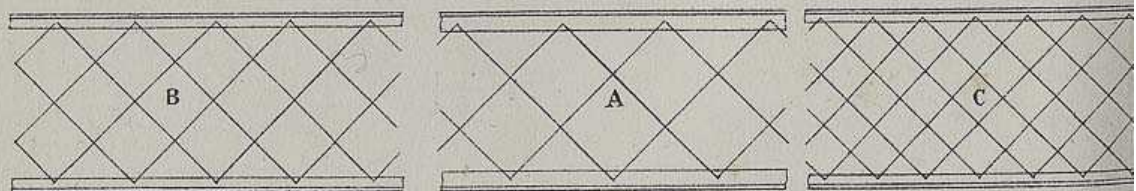



Fig.164

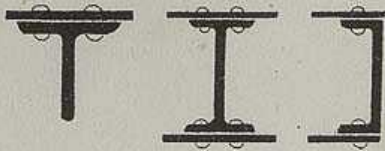

Fig. 165

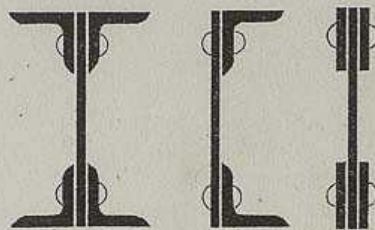

Fig. 167

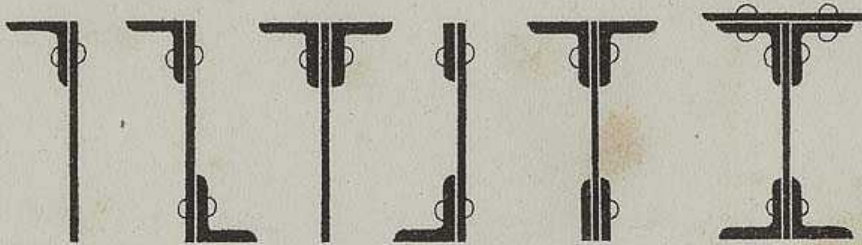

Fig. 169

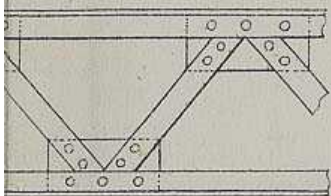

Fig. 170

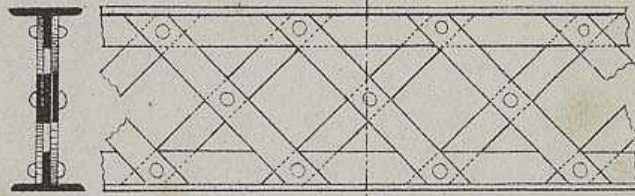

Fig. 173

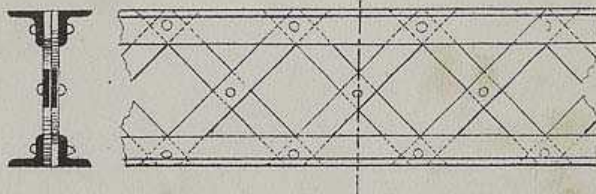

Fig. 177

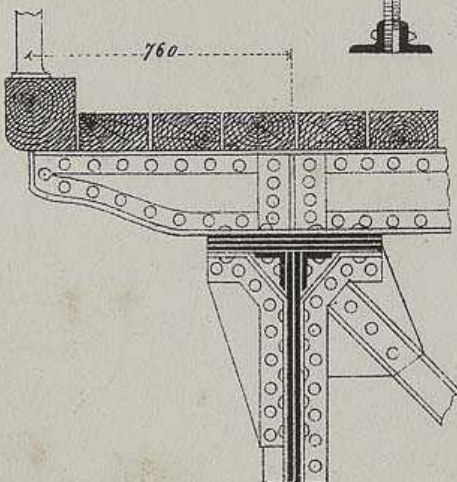

Fig. 176

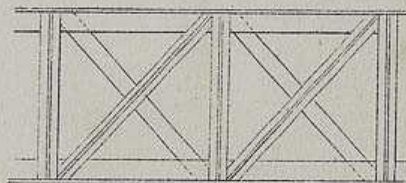

Fig. 175

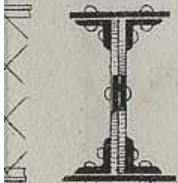



Fig. 178

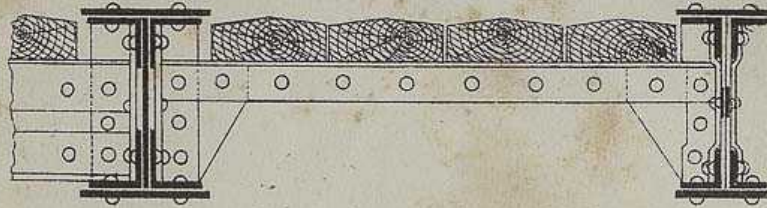

Fig. 179

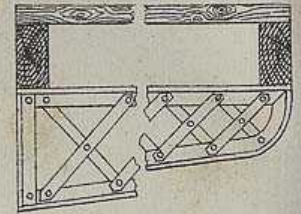

Fig. 182

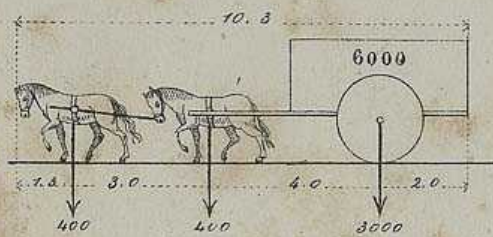

Fig. 184

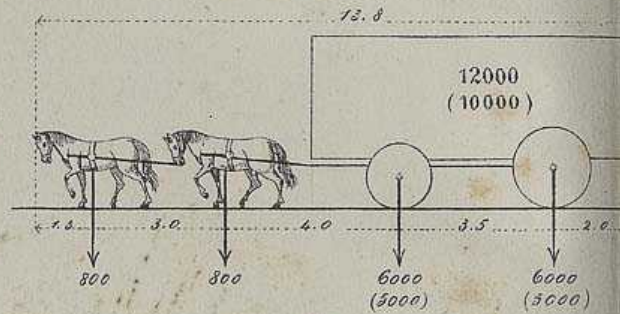

Fig. 187

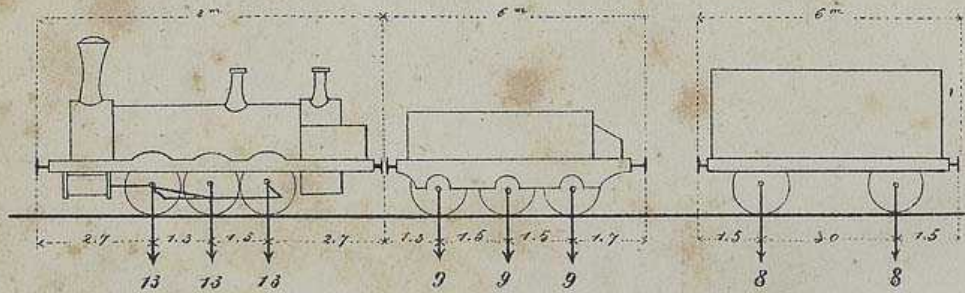

Fig. 188

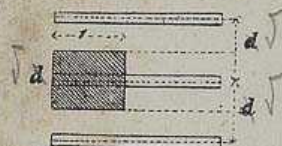

Fig. 194

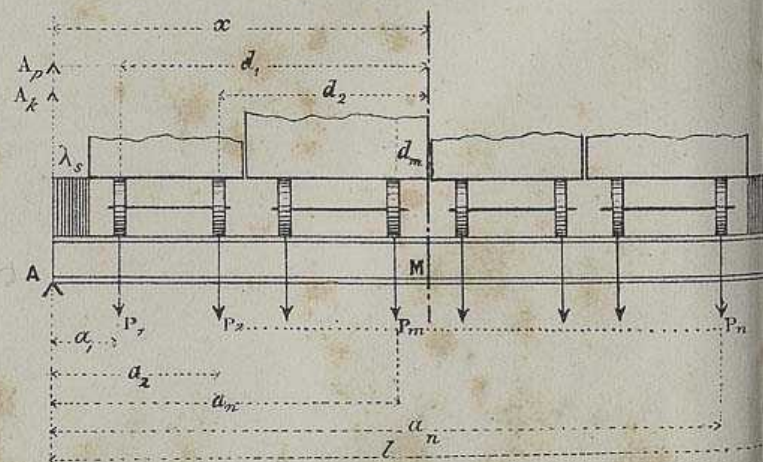

Fig. 189

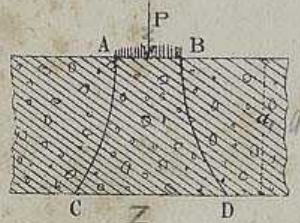



Fig. 180

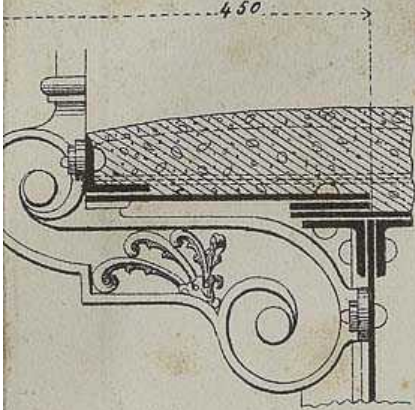

Fig. 181

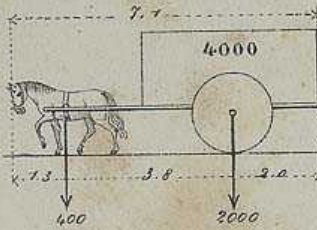

Fig. 183

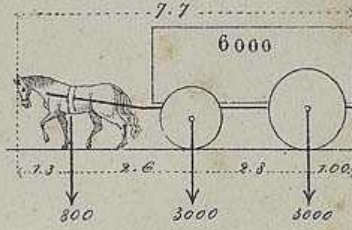

Fig. 185

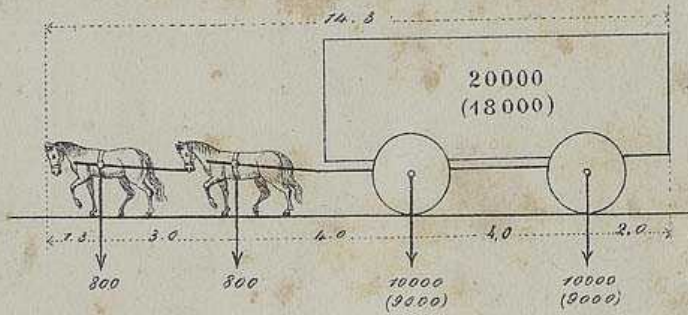

Fig. 186

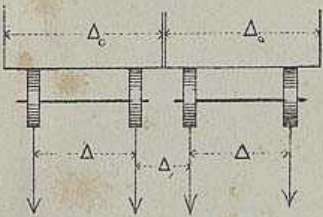

Fig. 192

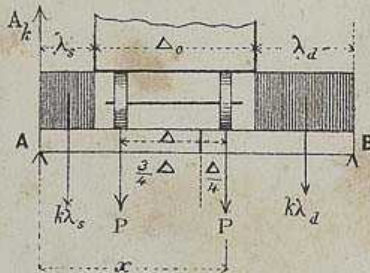

Fig. 193



Fig. 191

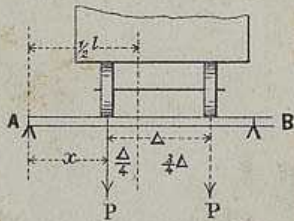

Fig. 195



Fig. 196

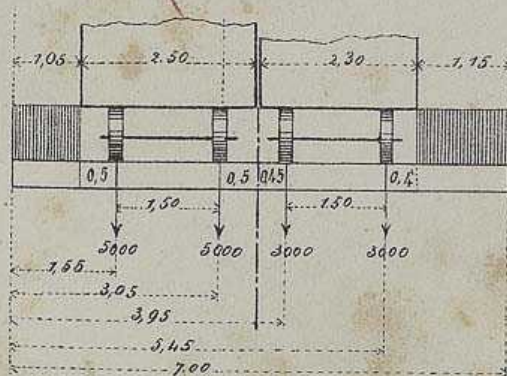

Fig. 197





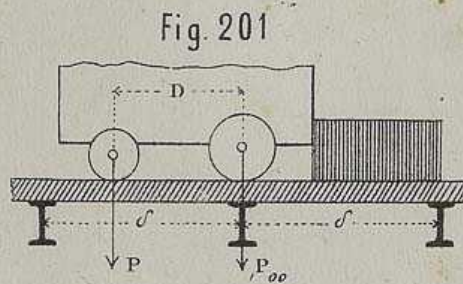
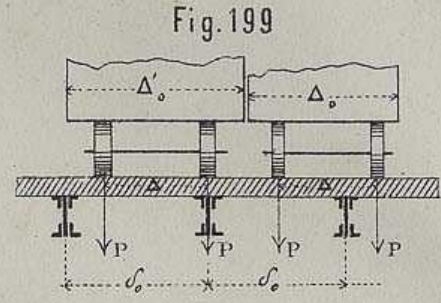
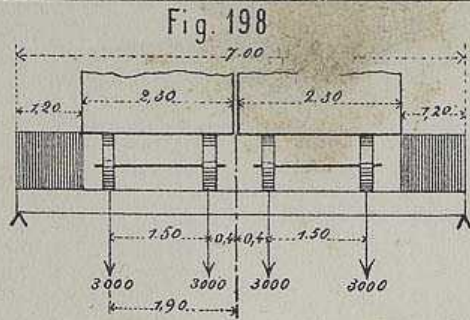

Fig. 203

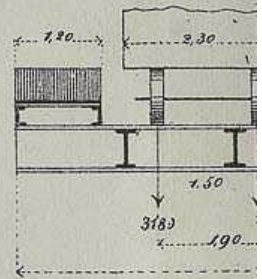
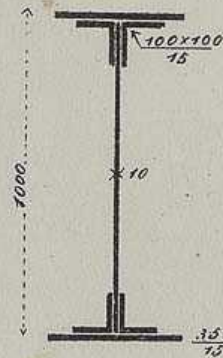

Fig. 209



Fig. 214

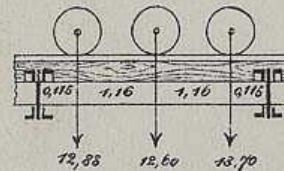

Fig. 210

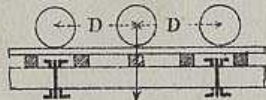

Fig. 211

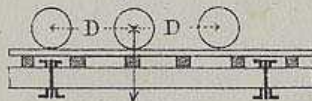

Fig. 212

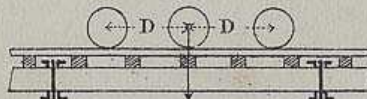

Fig. 213

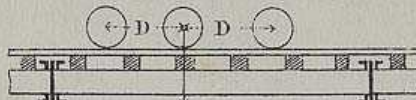

Fig. 215

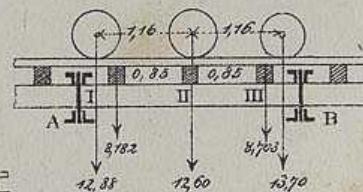

Fig. 218

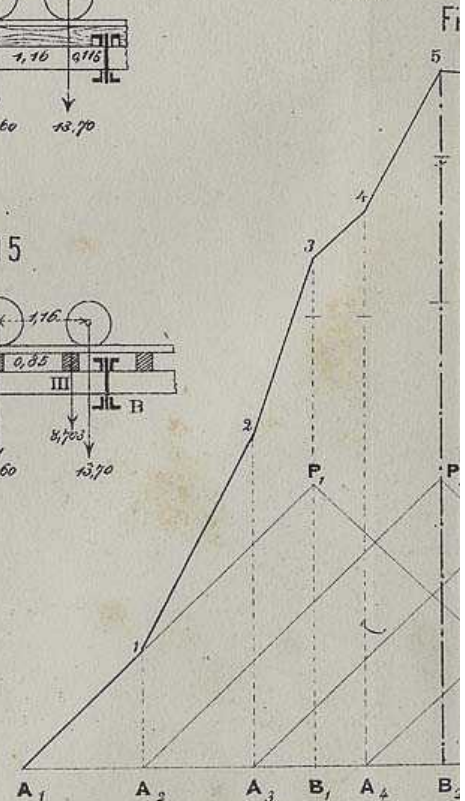
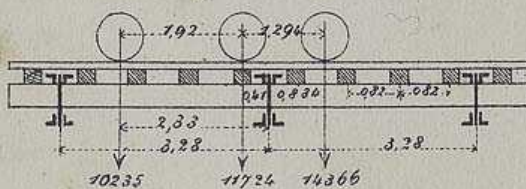



Fig. 200

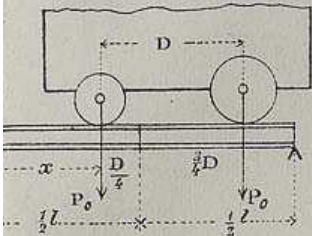
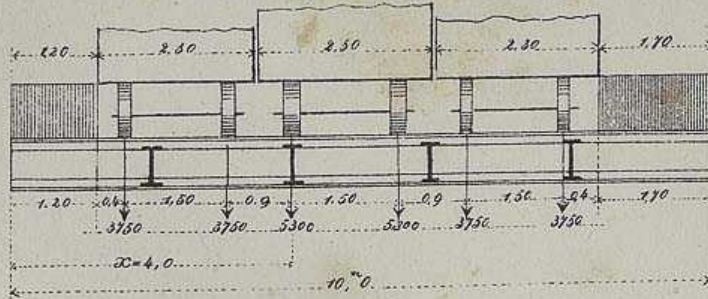

Fig. 202



204

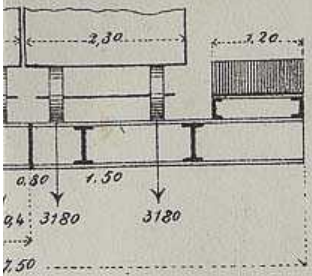

Fig. 205



Fig. 206

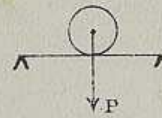
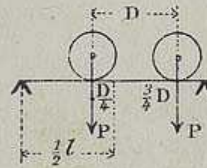

Fig. 207



217

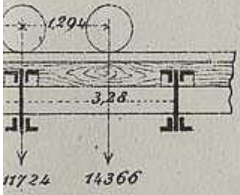

Fig. 216

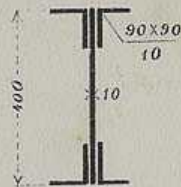
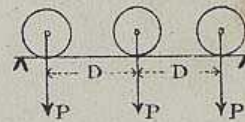

Fig. 208



g. 221

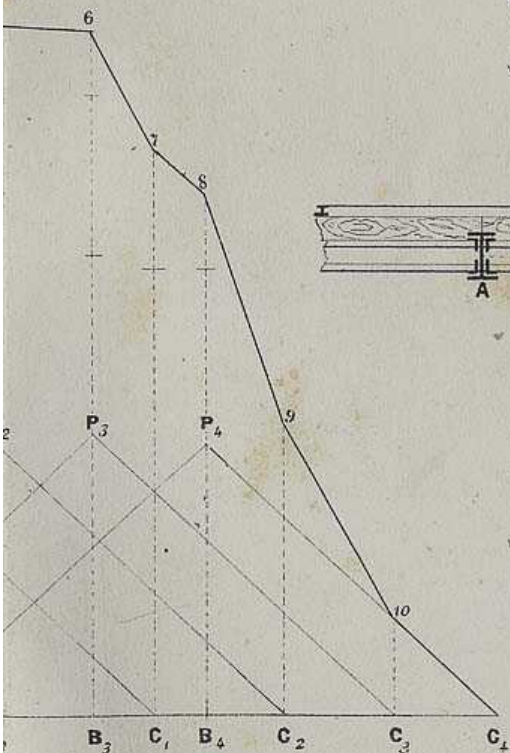

Fig. 220

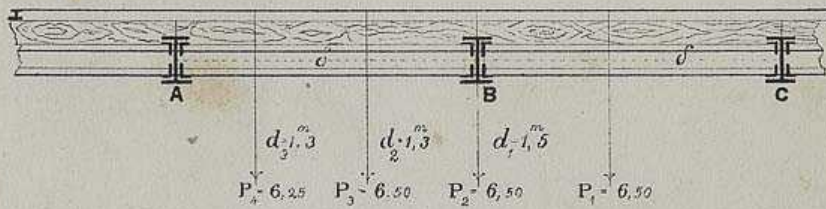

Fig. 219

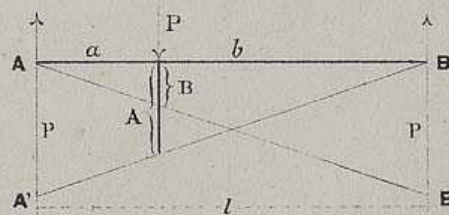



Fig. 222

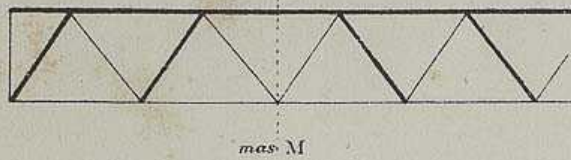

Fig. 223

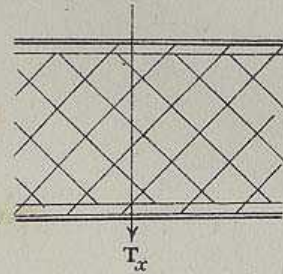

Fig. 227

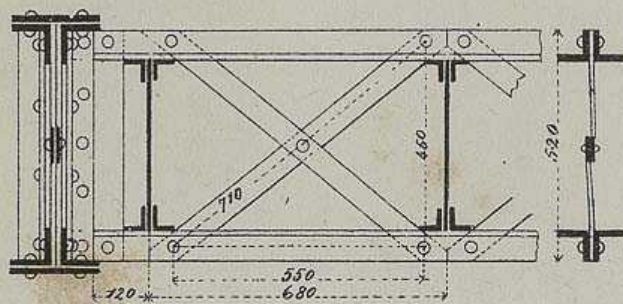

Fig. 228

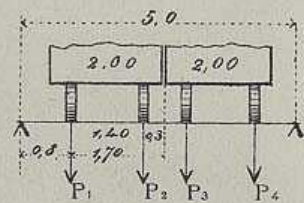

Fig. 231

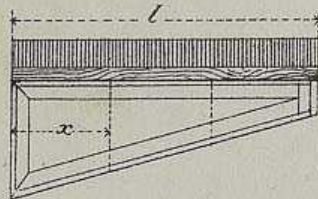

Fig. 232

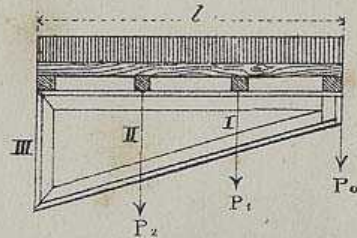

Fig. 234

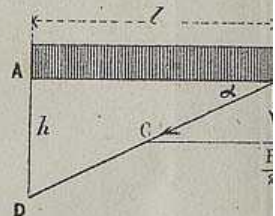

Fig. 237

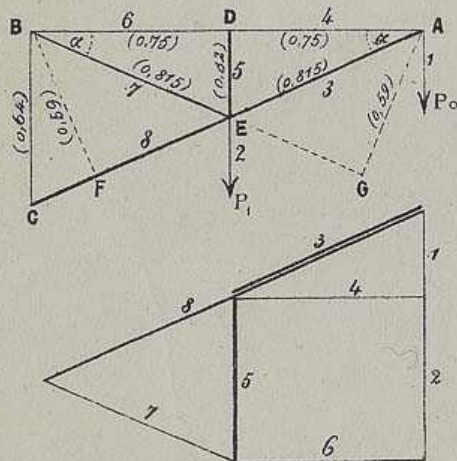

Fig. 238

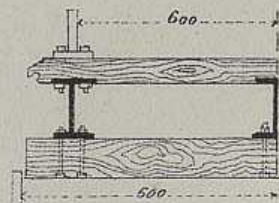

Fig. 240

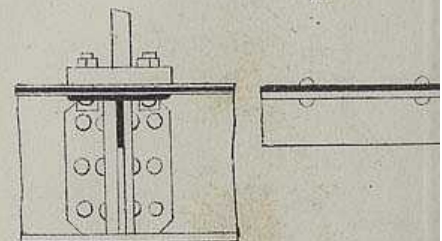



Fig. 224

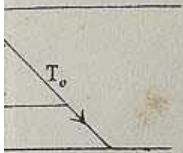

Fig. 225

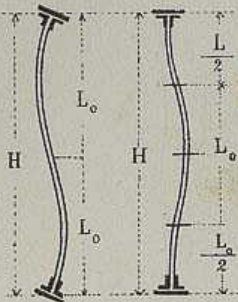

Fig. 226

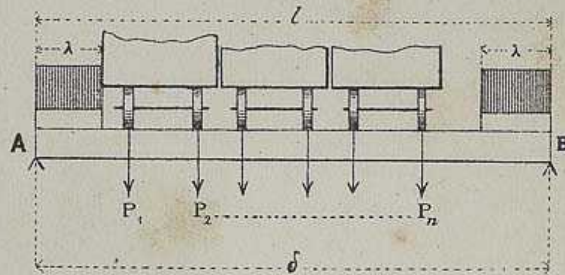

Fig. 229

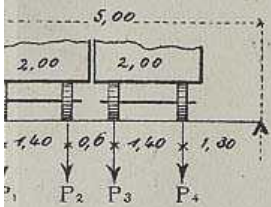

Fig. 230

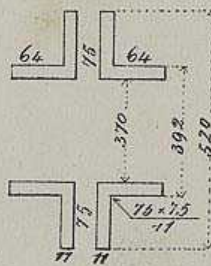

Fig. 233

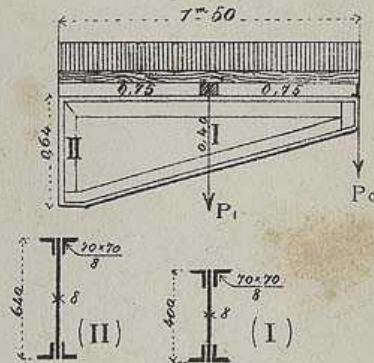

Fig. 235

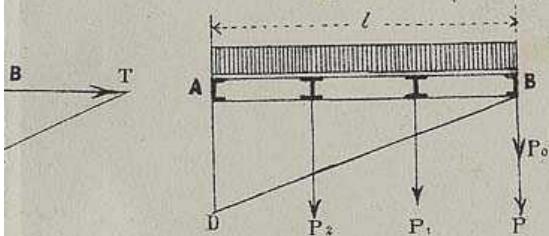

Fig. 236

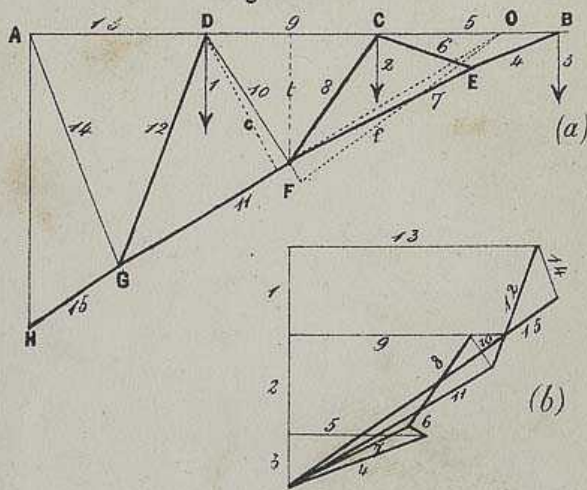

Fig. 239

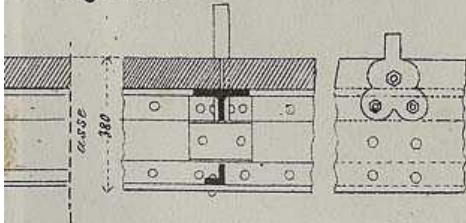

Fig. 241

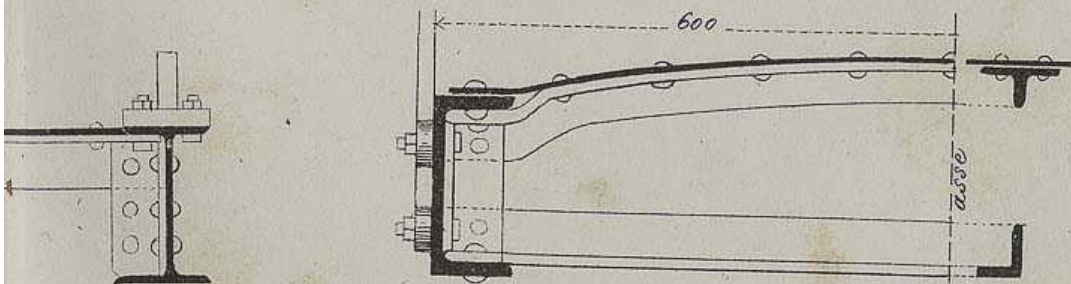



Fig. 242

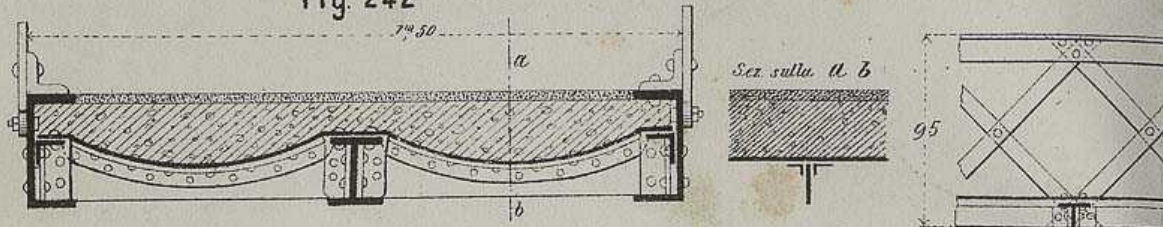

Fig. 245

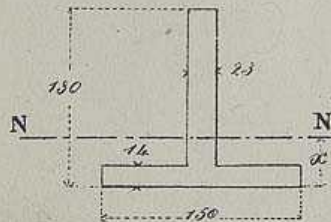

Fig. 246

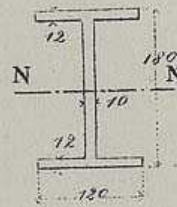

Fig. 247



Fig. 248

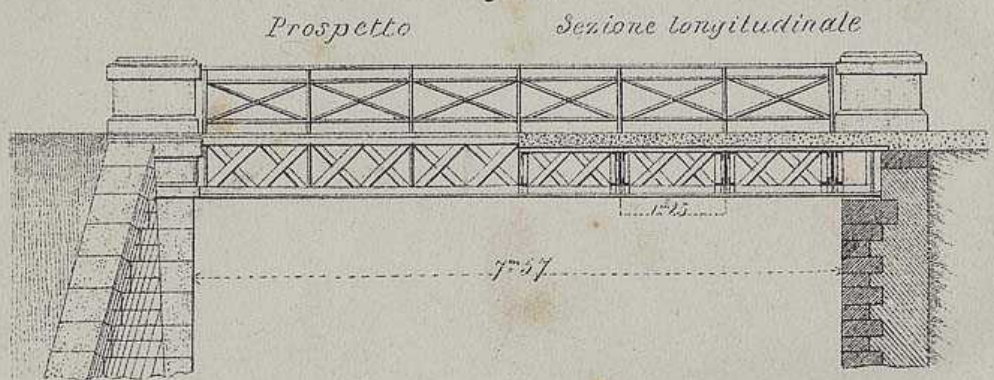

Fig. 252

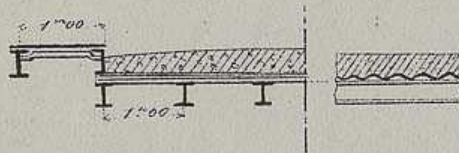

Fig. 253

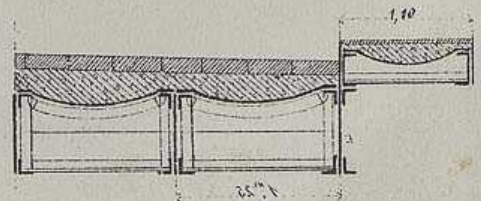

Fig. 254

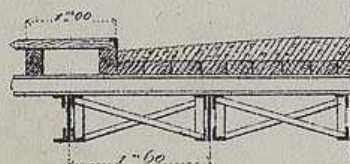

Fig. 255

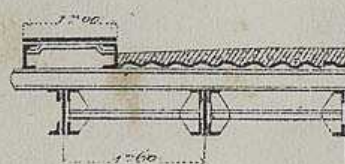

Fig. 25

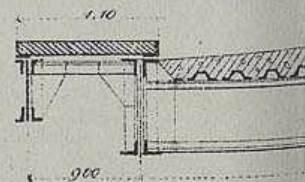







Fig. 260

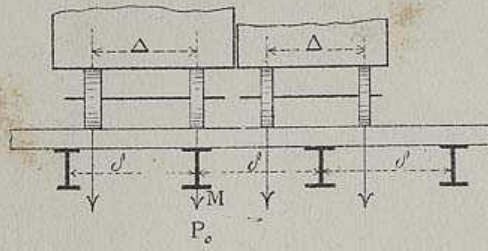

Fig. 261

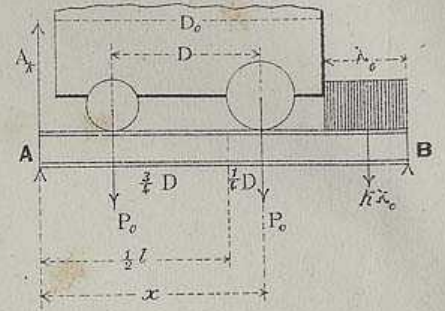

Fig. 265

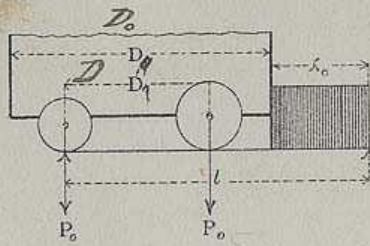

Fig. 266



Fig. 267

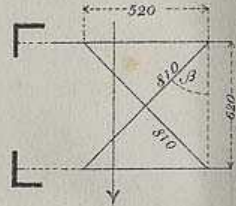

Fig. 268

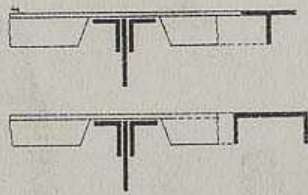

Fig. 272

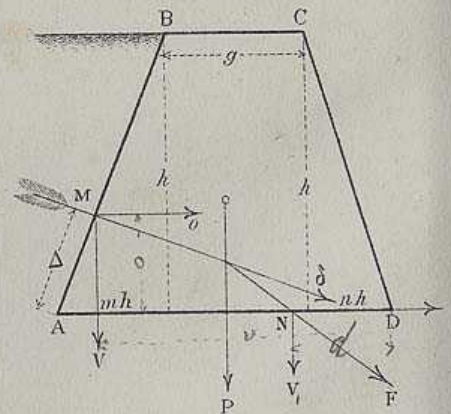

Fig. 270

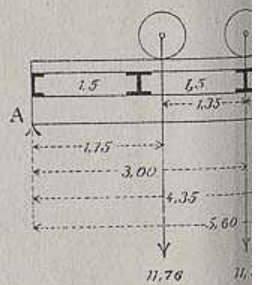
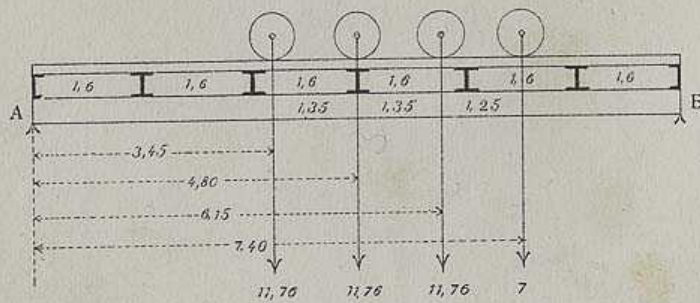







Fig. 275

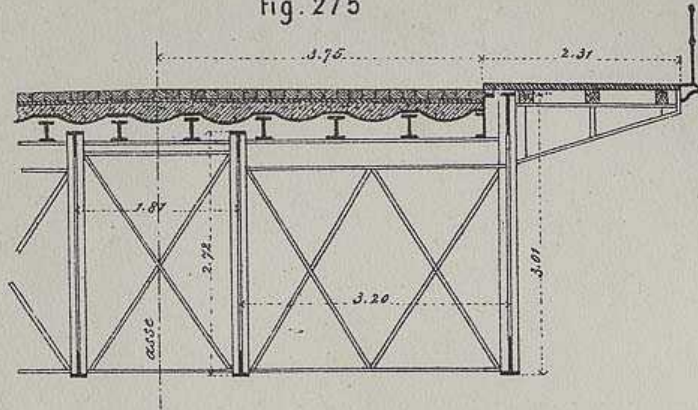

Fig. 276

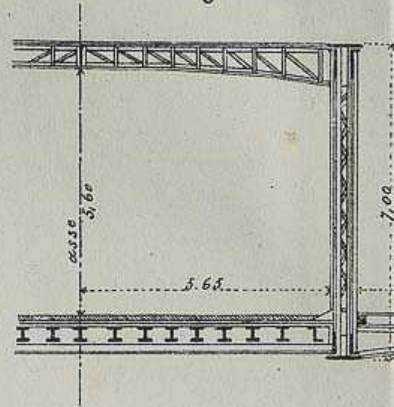

Fig. 280

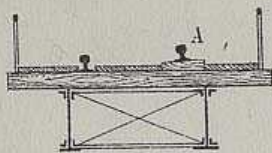

Fig. 281

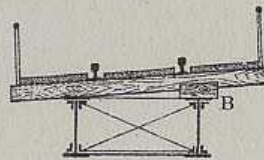

Fig. 282

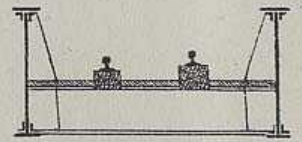

Fig. 288

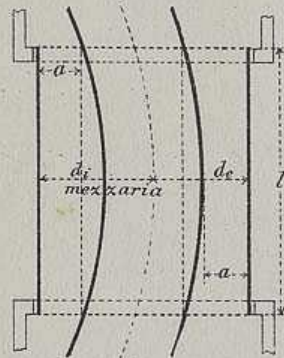

Fig. 286

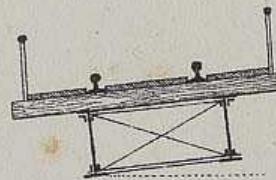

Fig. 287

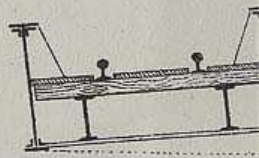

Fig. 279

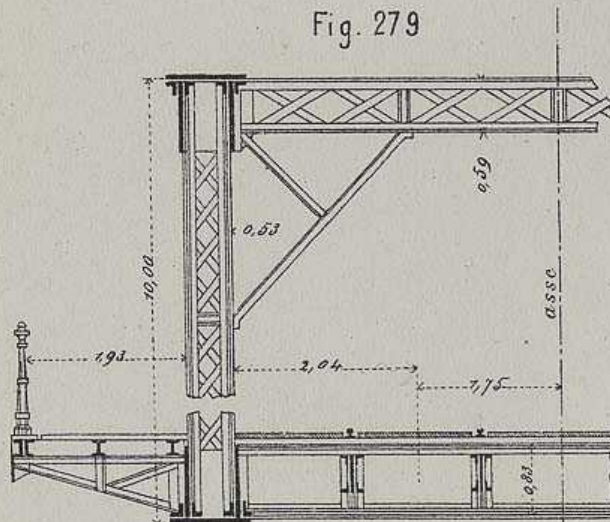

Fig. 289

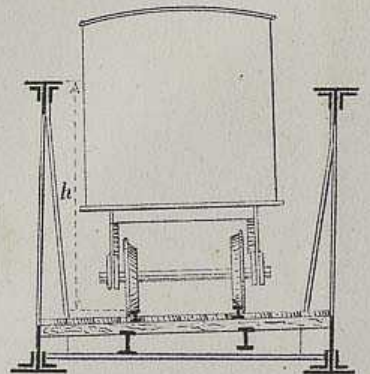



Fig. 277

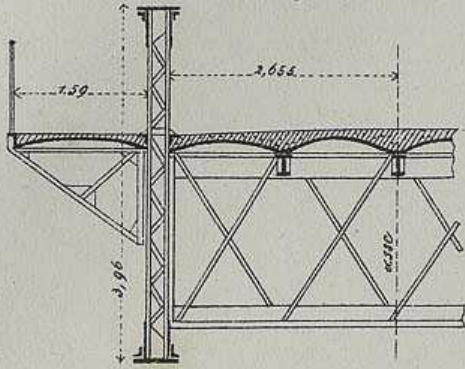

Fig. 278

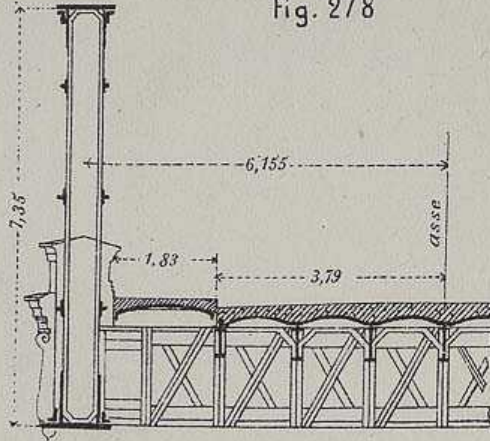

Fig. 283

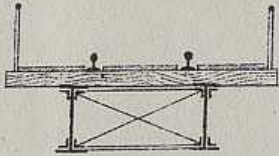

Fig. 284

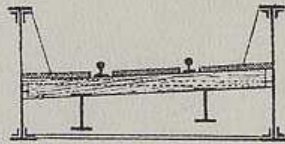

Fig. 285

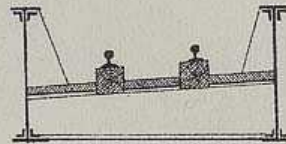

Fig. 290

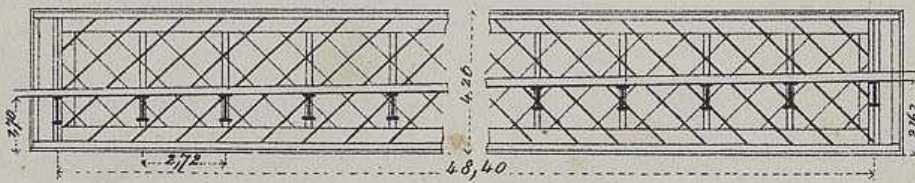

Fig. 291

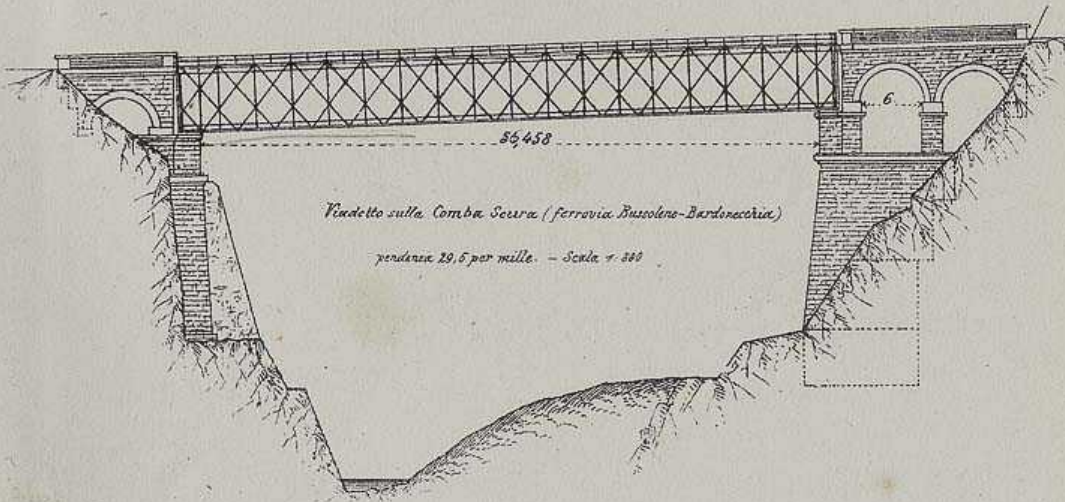



Fig. 293

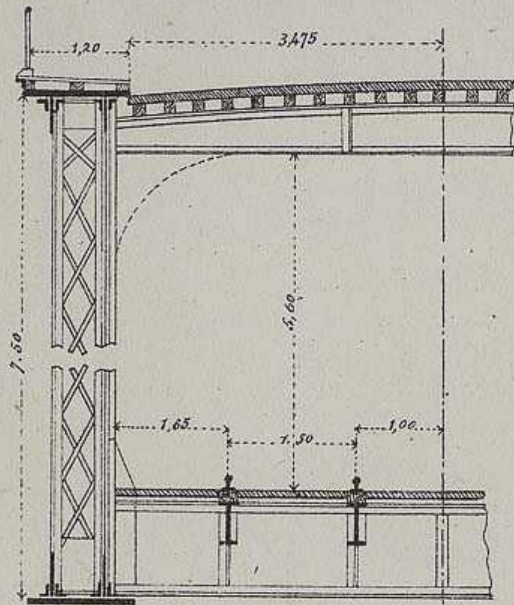

Fig. 292

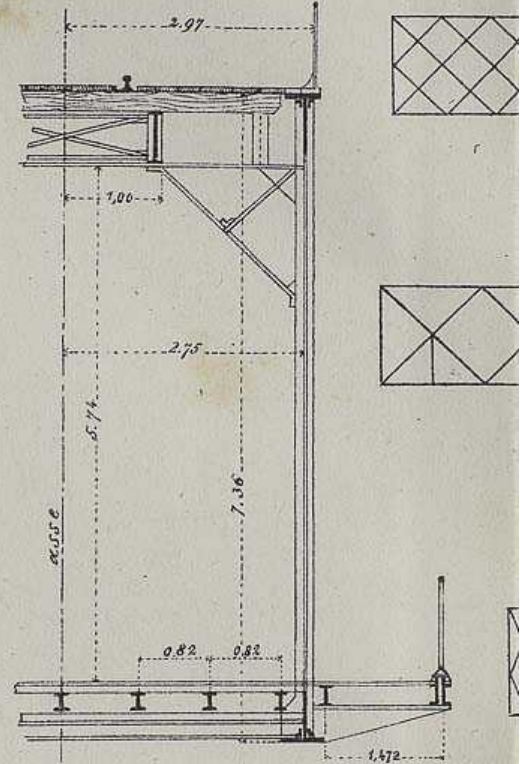

Fig. 300

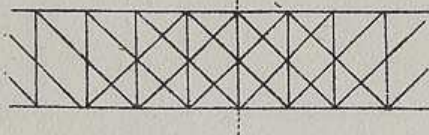

Fig. 297

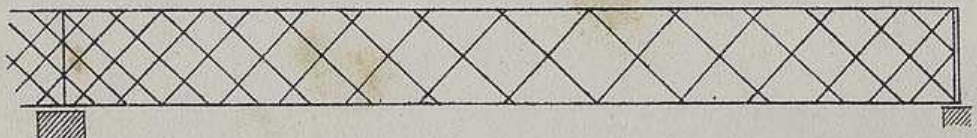

Fig. 301

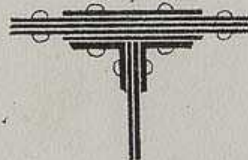

Fig. 306

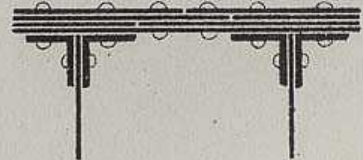

Fig. 305

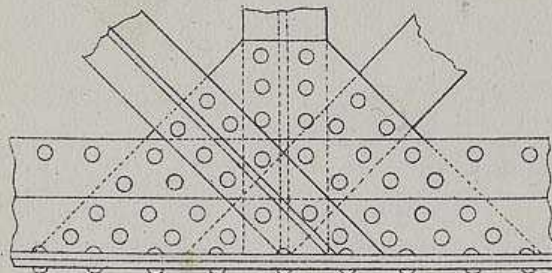

Fig. 306

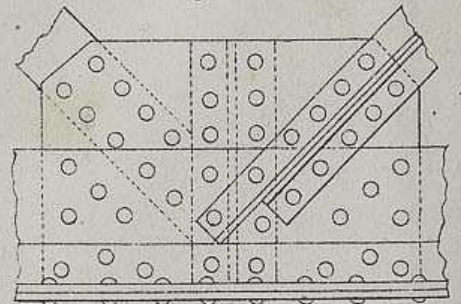



Fig. 295      Fig. 296

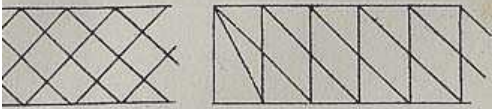

Fig. 299

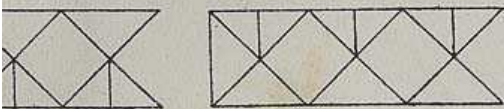

Fig. 298

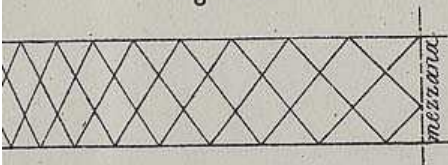

Fig. 304

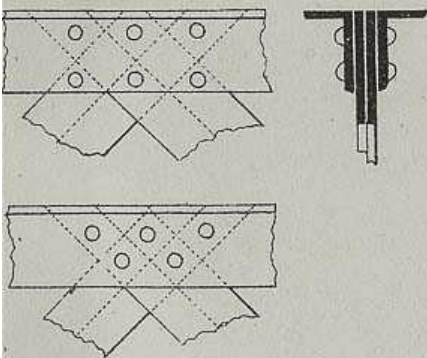

Fig. 294

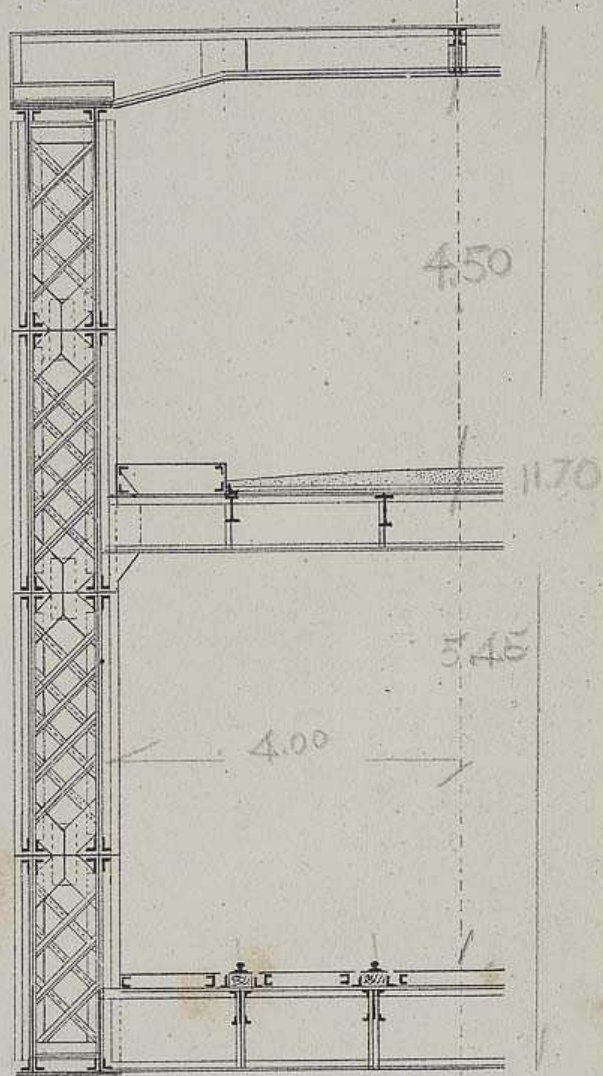

Fig. 303

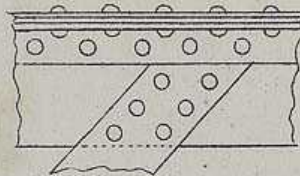

Fig. 307

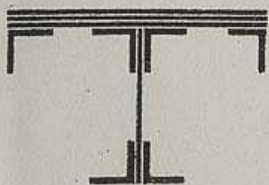

Fig. 308

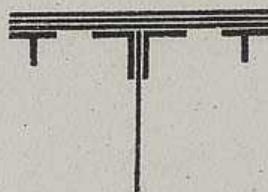

Fig. 309





Fig. 310

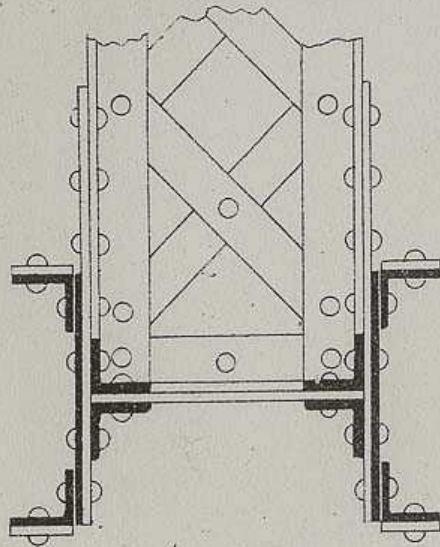

Fig. 312

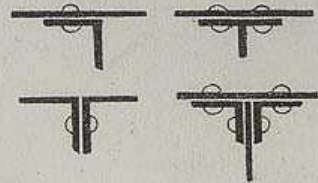

Fig. 317

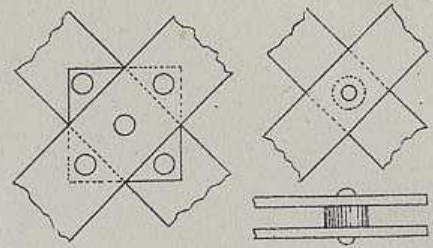

Fig. 311

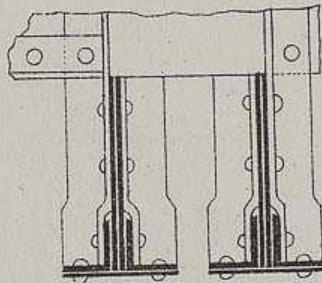

Fig. 320

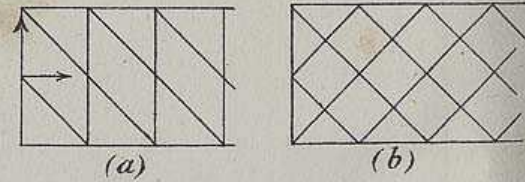

Fig. 326

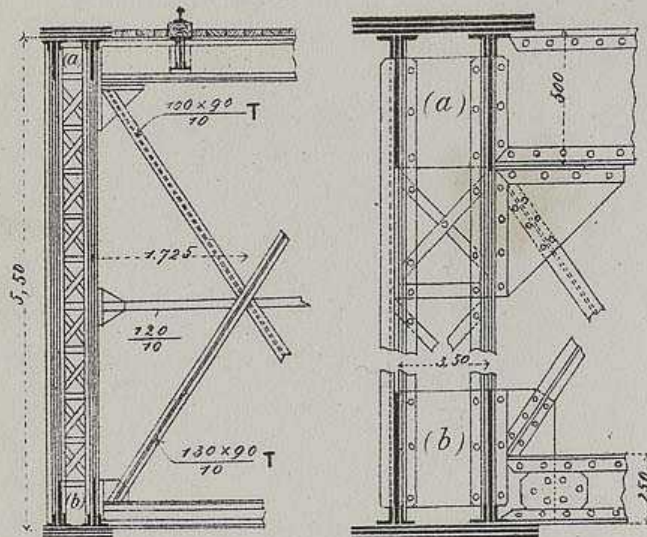

Fig. 322

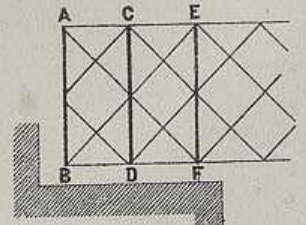

Fig. 324

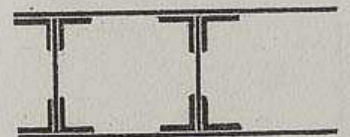



Fig. 313

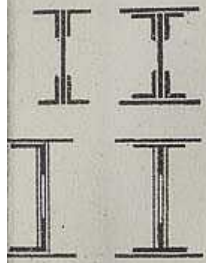

Fig. 314

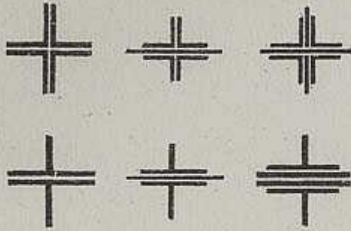

Fig. 315

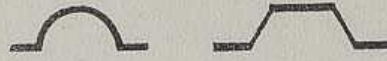

Fig. 316

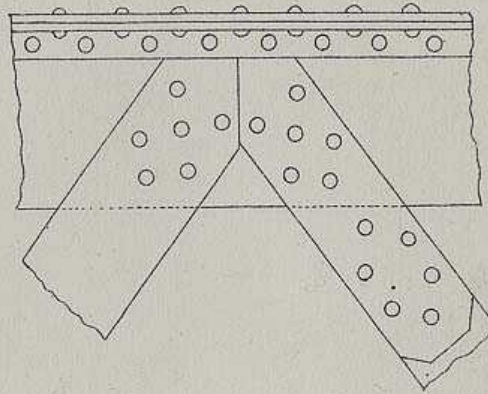

Fig. 318

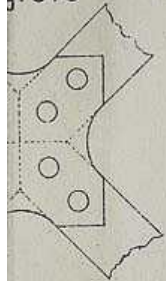

Fig. 319

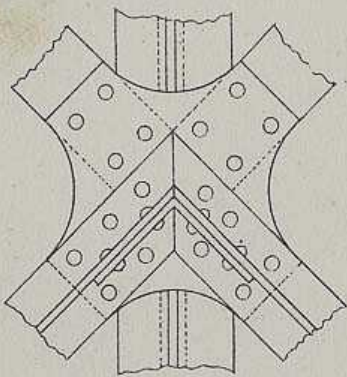

Fig. 321

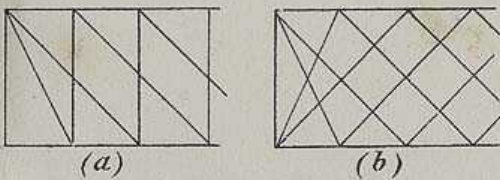

Fig. 325

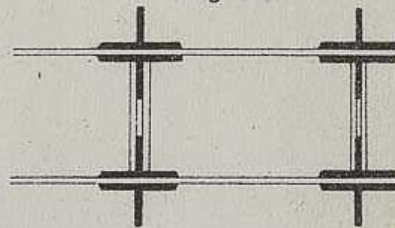

Fig. 323

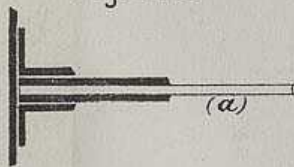

Fig. 327

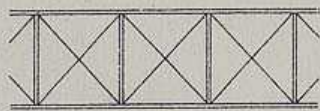

Fig. 328

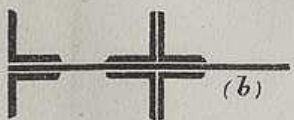
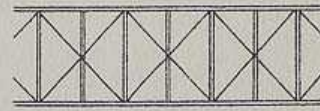

Fig. 329

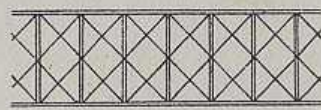

Fig. 330

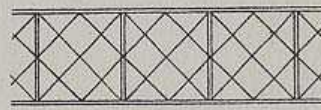

Fig. 331

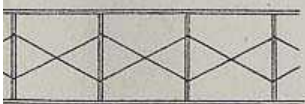

Fig. 332



Fig. 333

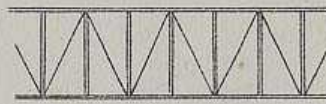



Fig. 334

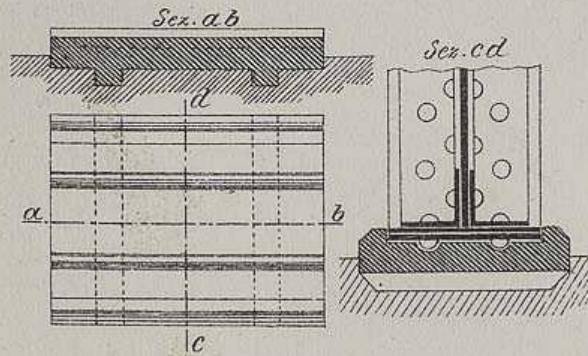

Fig. 335

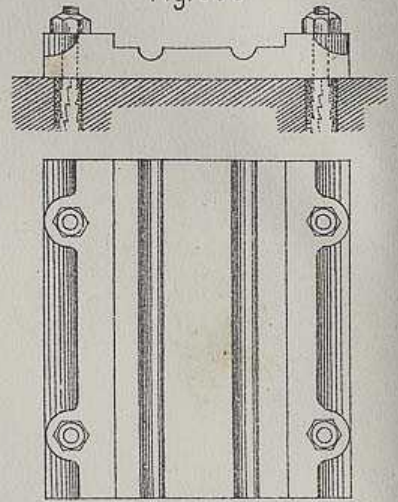

Fig. 339

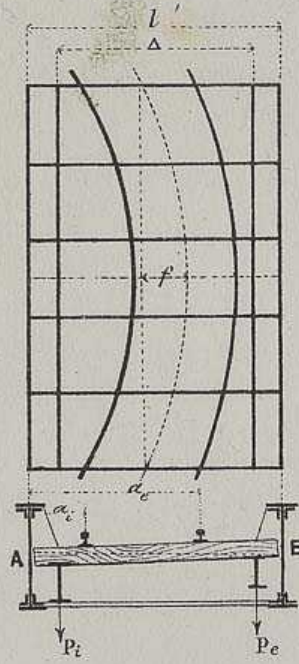

Fig. 340

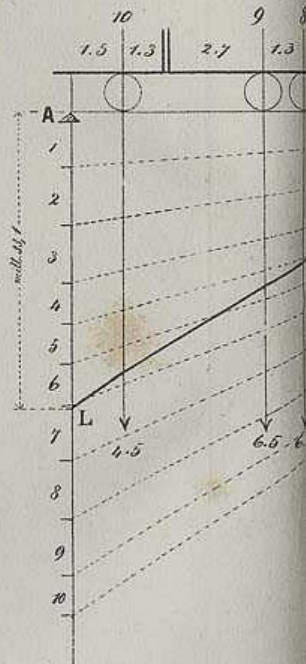
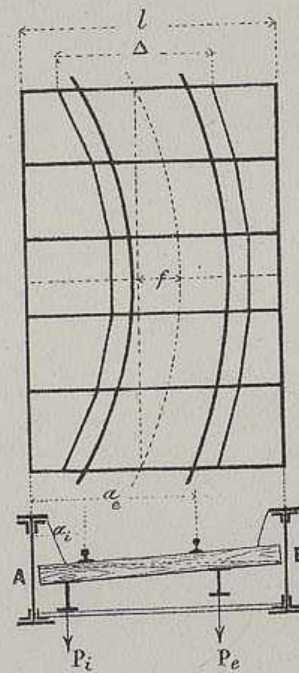

Fig. 342

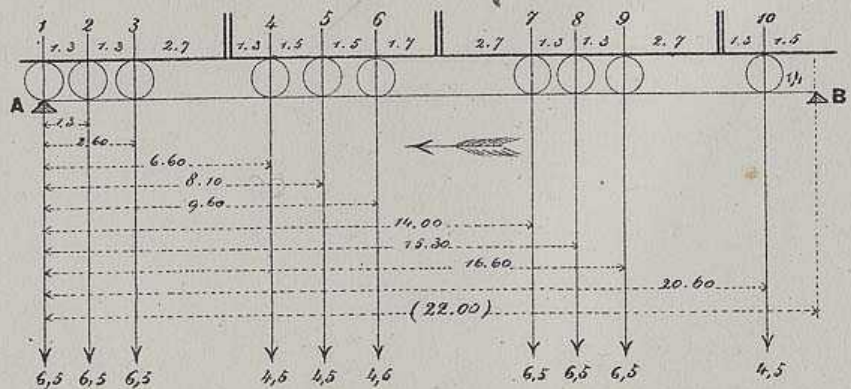



Fig. 336

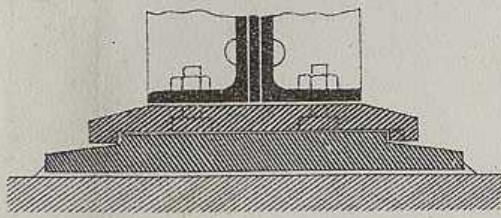

Fig. 338

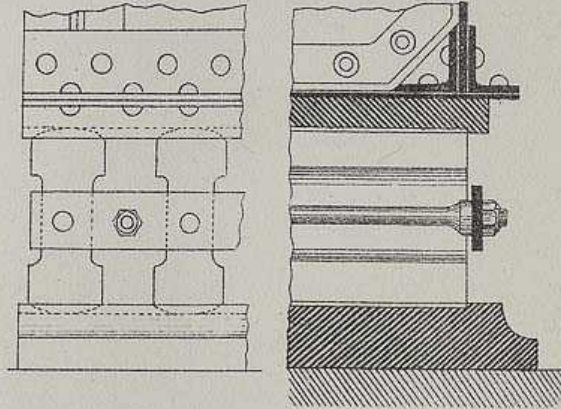
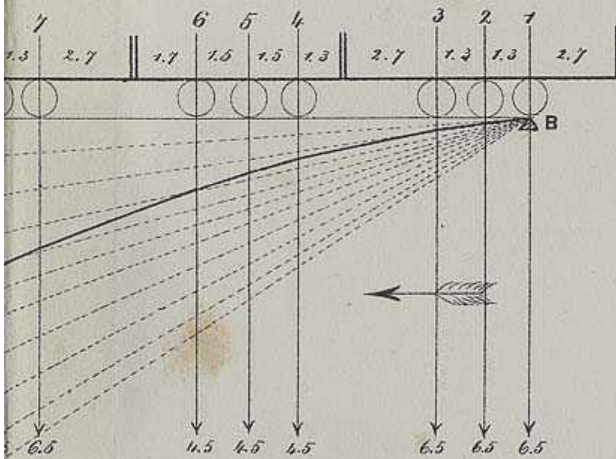

Fig. 343



Scala delle lunghezze 4 mill. per metro  
 " " forze 1 " " tonn.

Fig. 337



Fig. 341

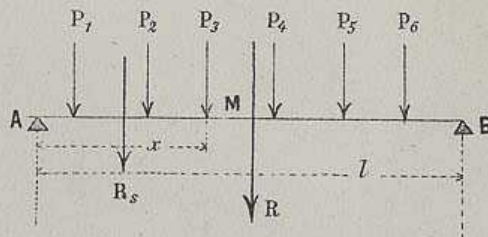

Fig. 344

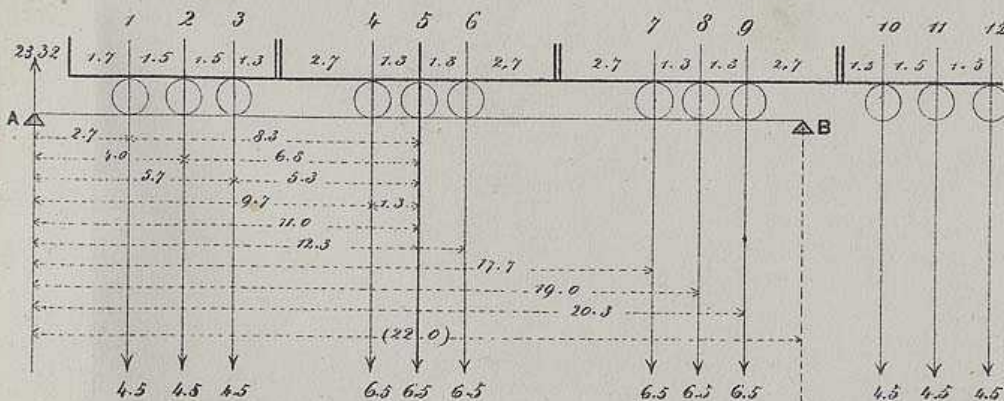



Fig. 345

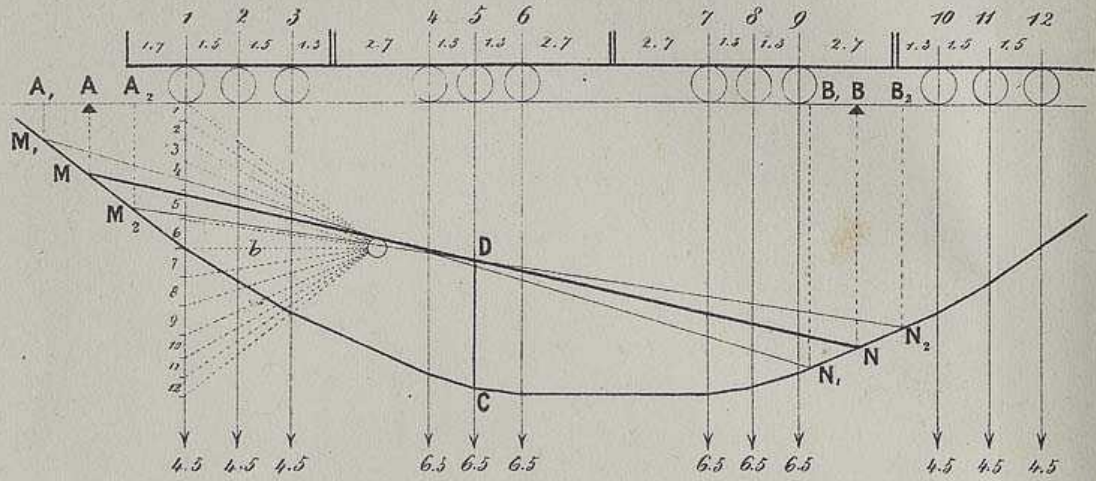

Fig. 347

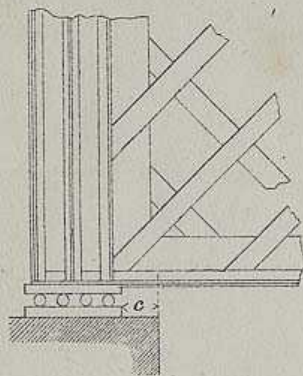

Fig. 348

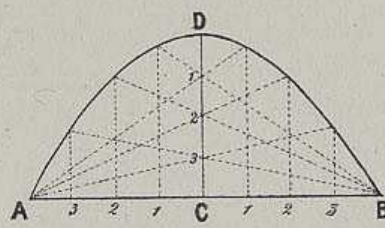

Fig. 349

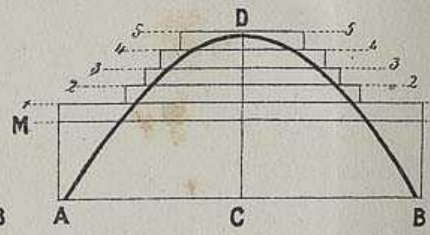

Fig. 352

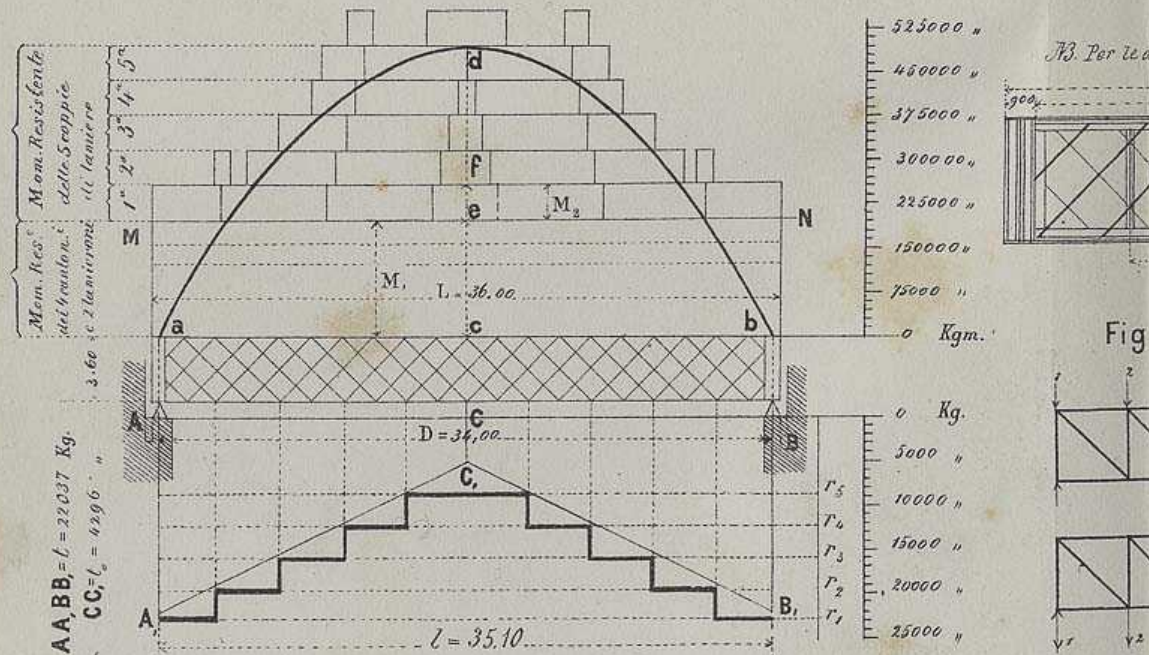



Fig. 346

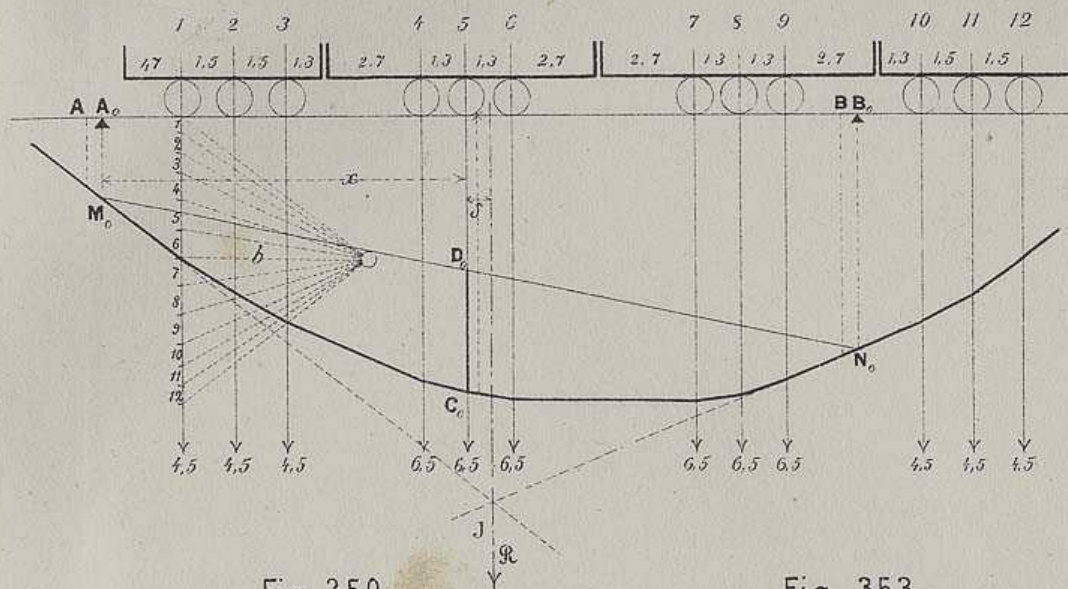

Fig. 350

Fig. 353

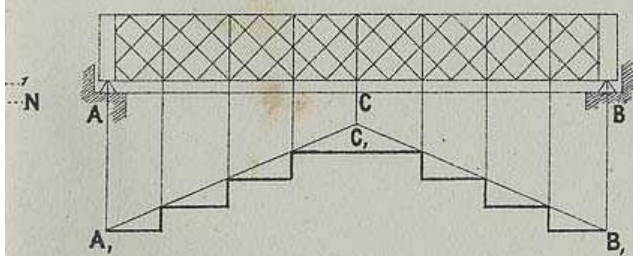

Fig. 354

diagonali bisogna invertire le posizioni del carico mobile

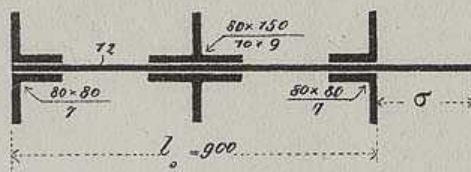
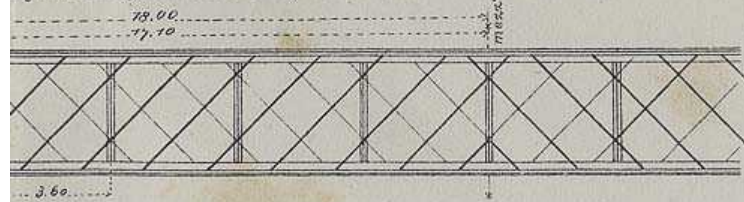
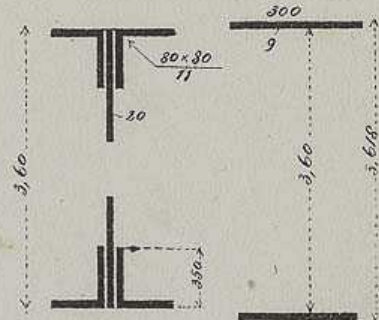

Fig. 351



355

Fig. 356

Fig. 357

Fig. 358

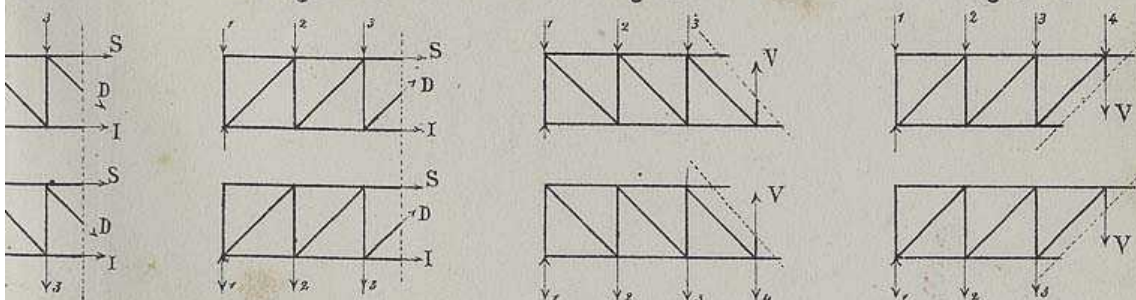



Fig. 359

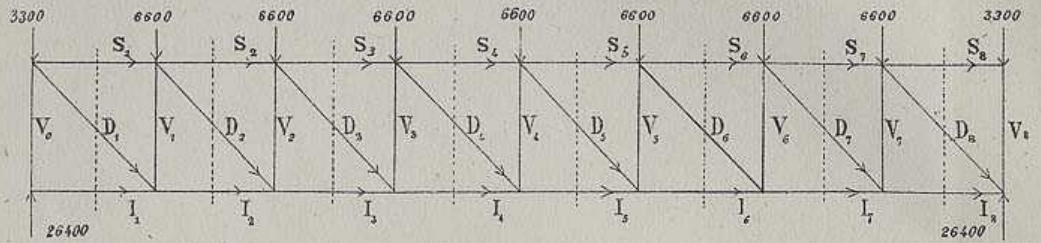

Fig. 361

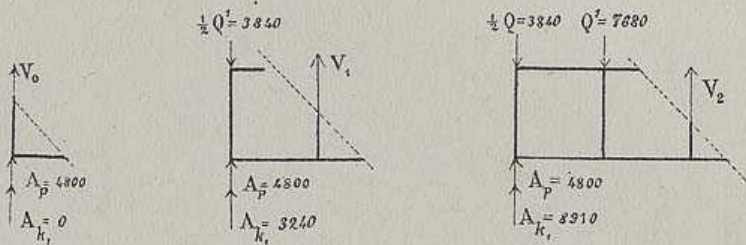

Fig. 362

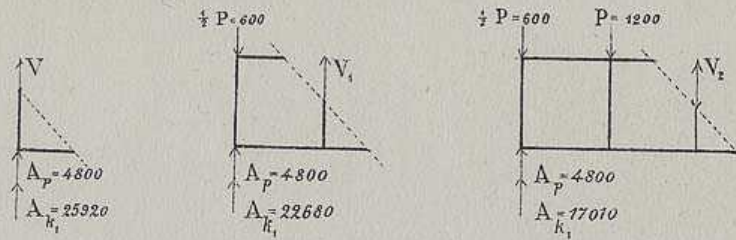

Fig. 365

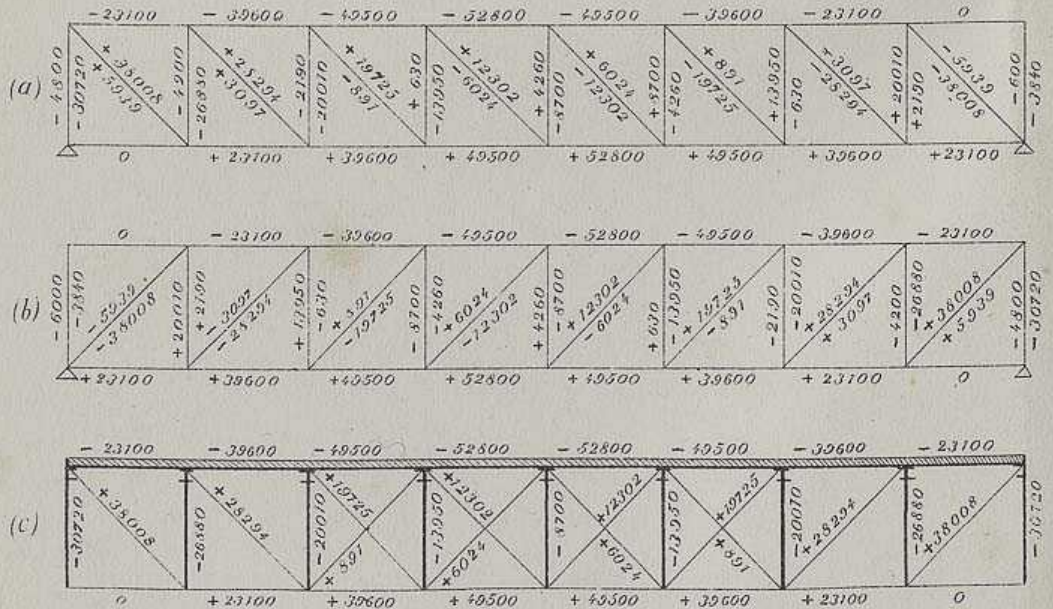



Fig 363

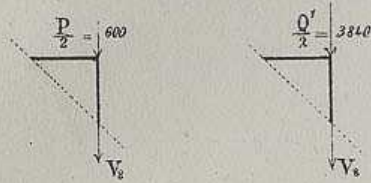

Fig 364

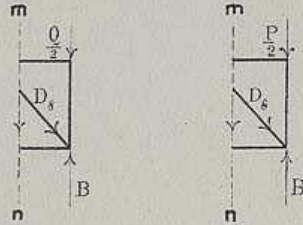

Fig. 360

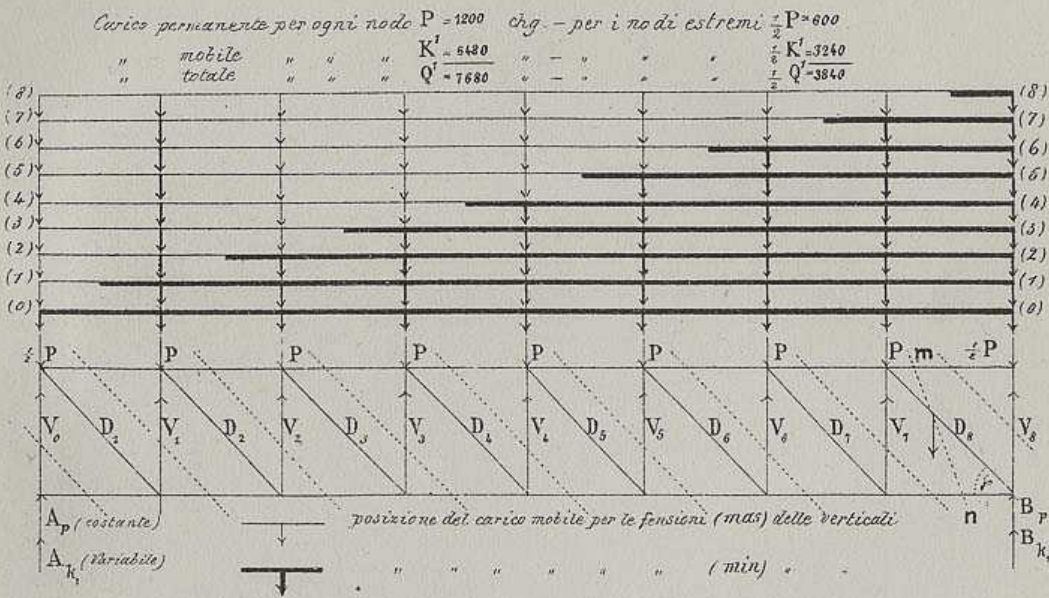

Fig. 366

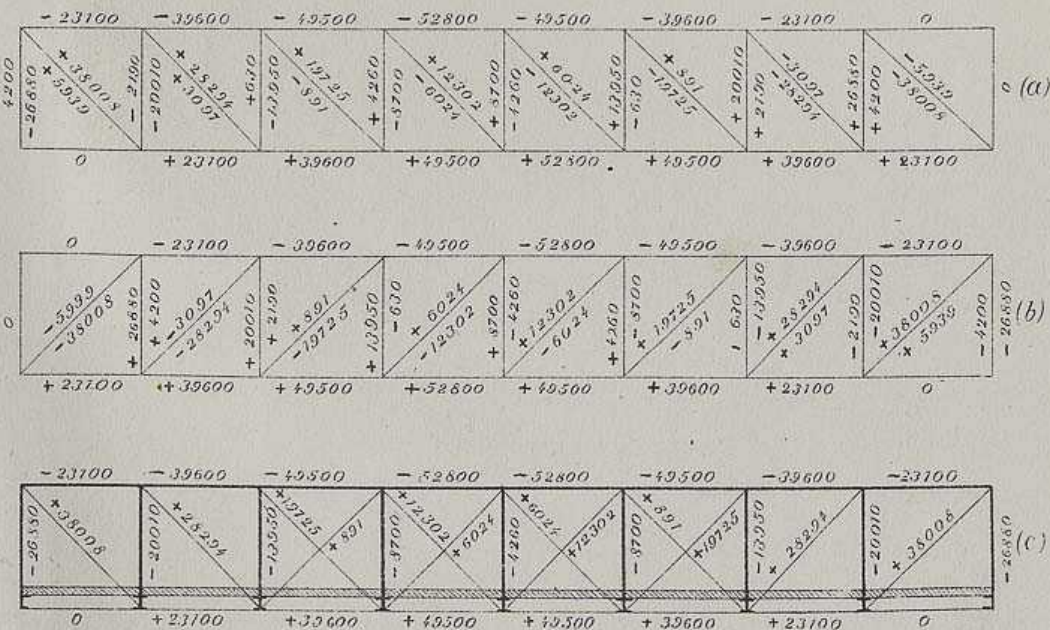



Fig. 367

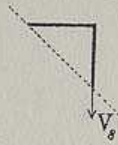

Fig. 369

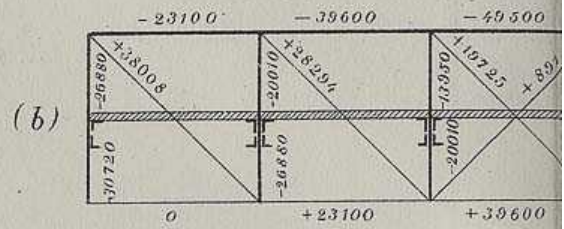
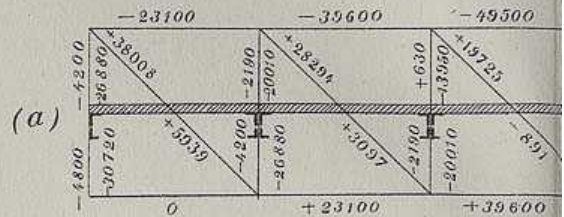
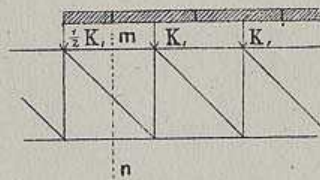

Fig. 370

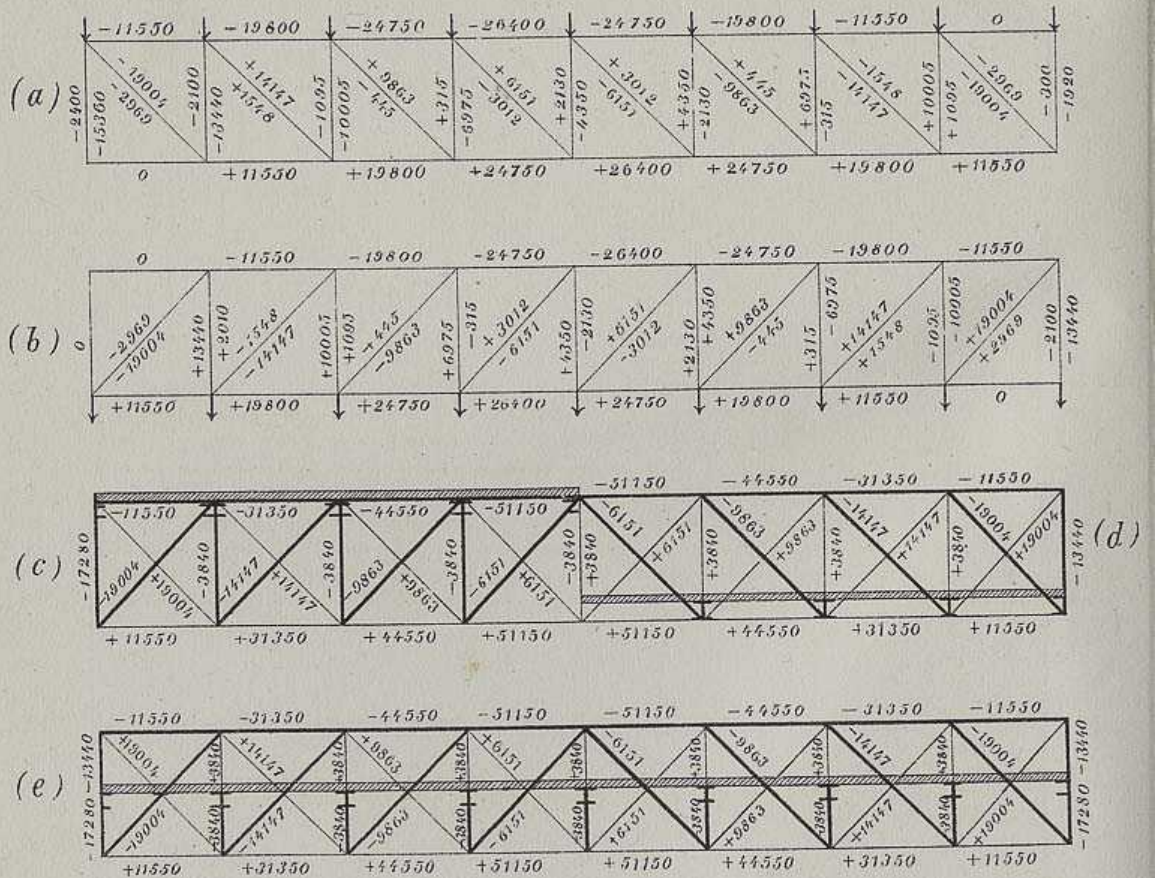



Fig. 368

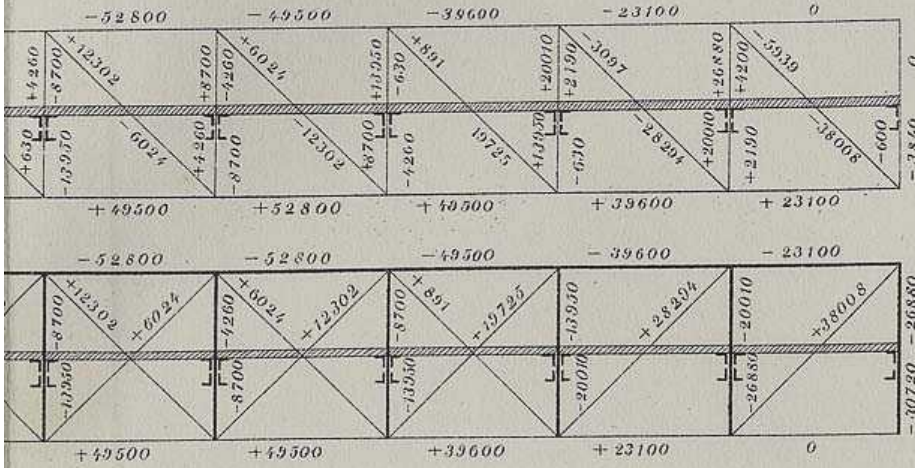

Fig. 371

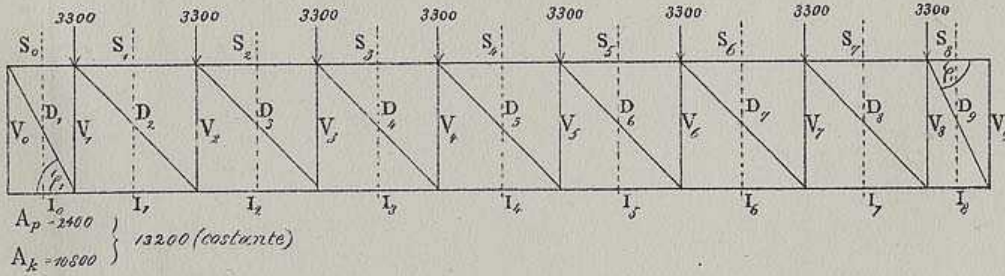
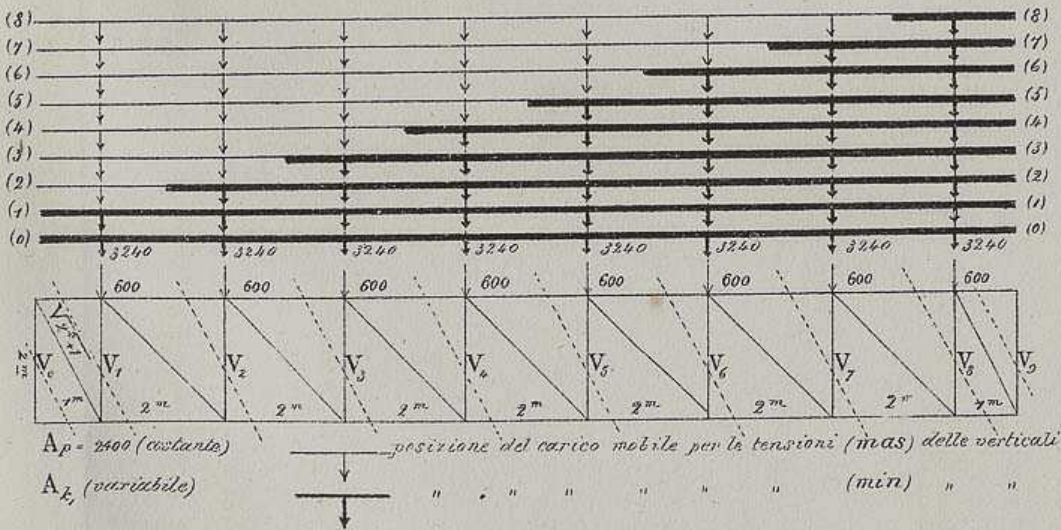

Fig. 372









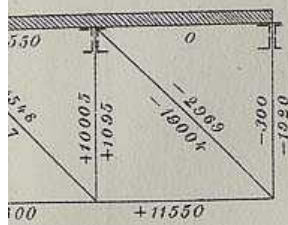

Fig. 377

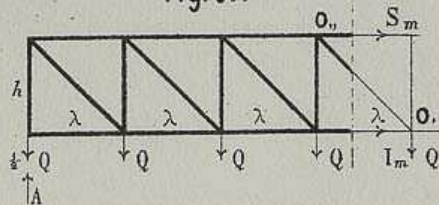

Fig. 378

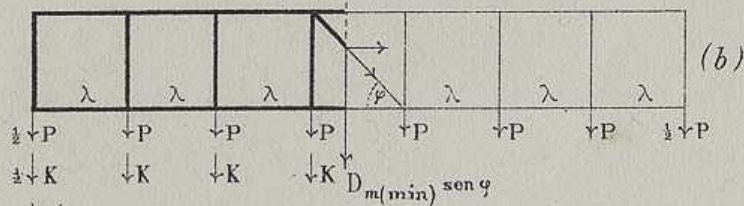
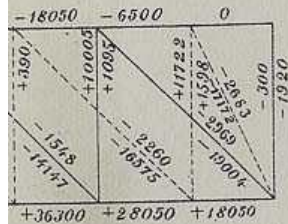
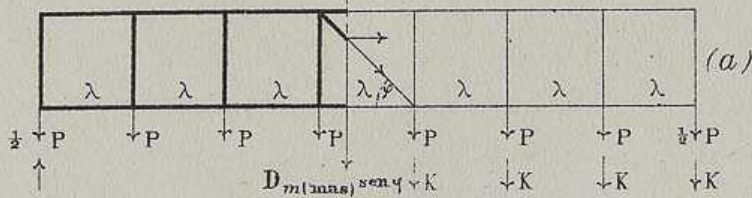
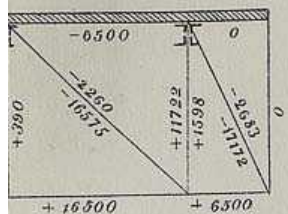

Fig. 379

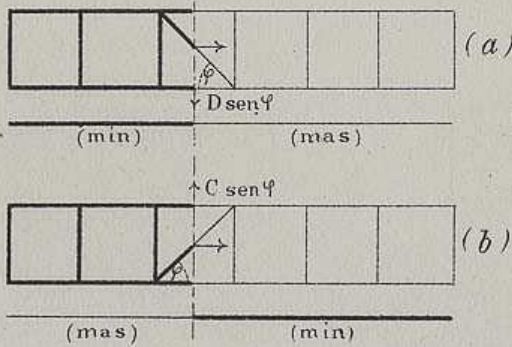
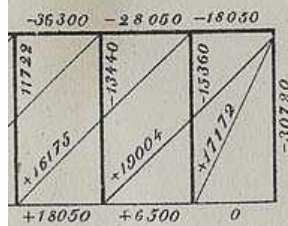
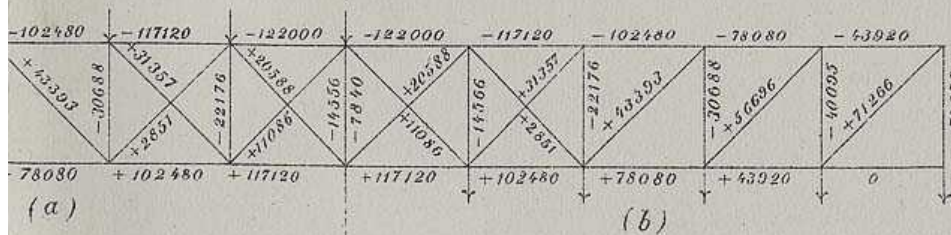

Fig. 381



(b)







Fig. 385

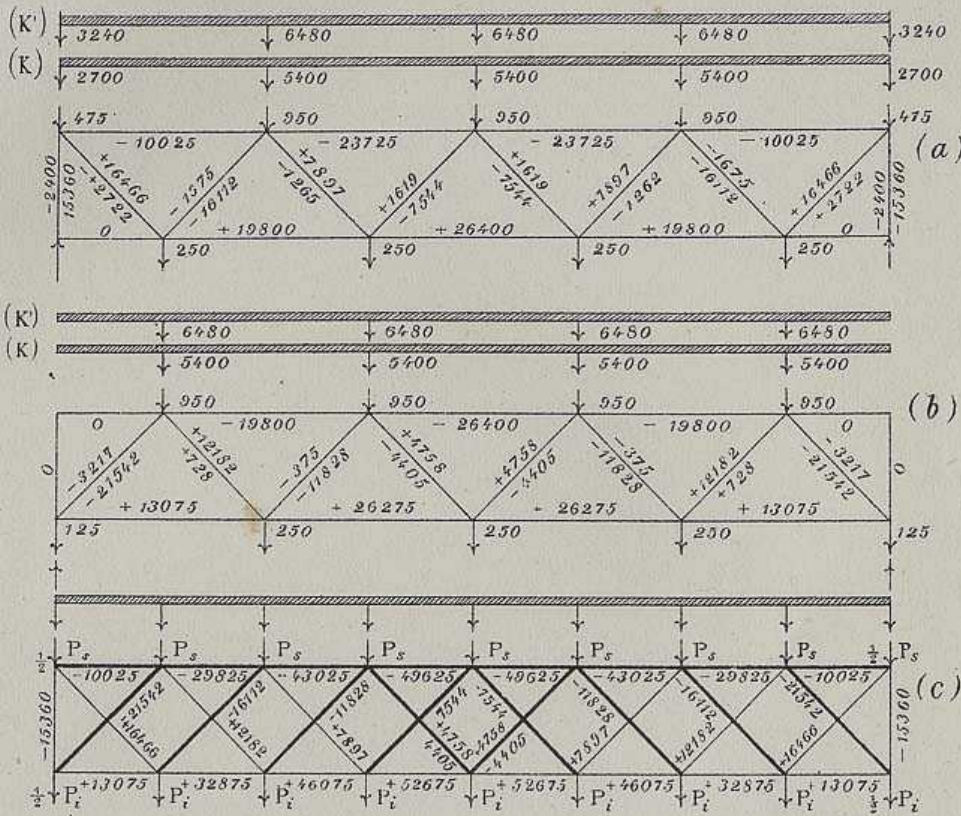

Fig. 388

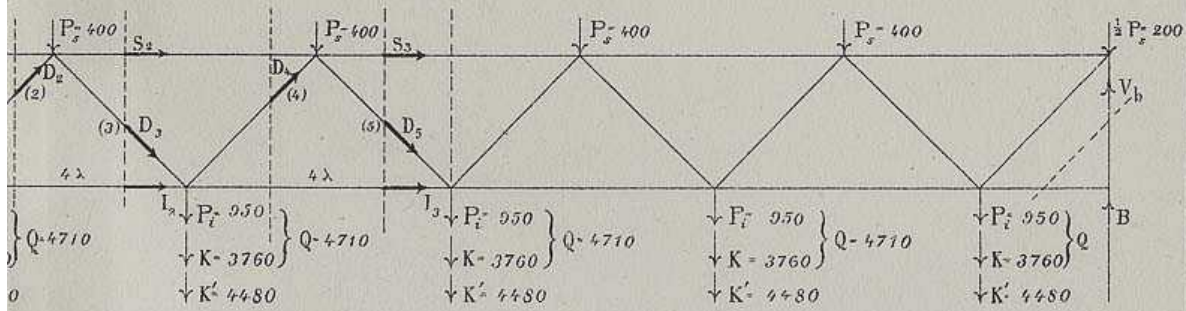

Fig. 389

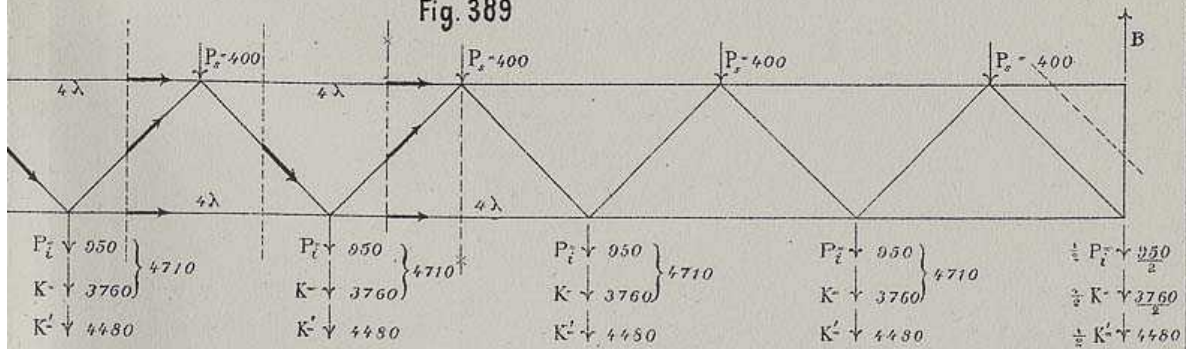



Fig. 390

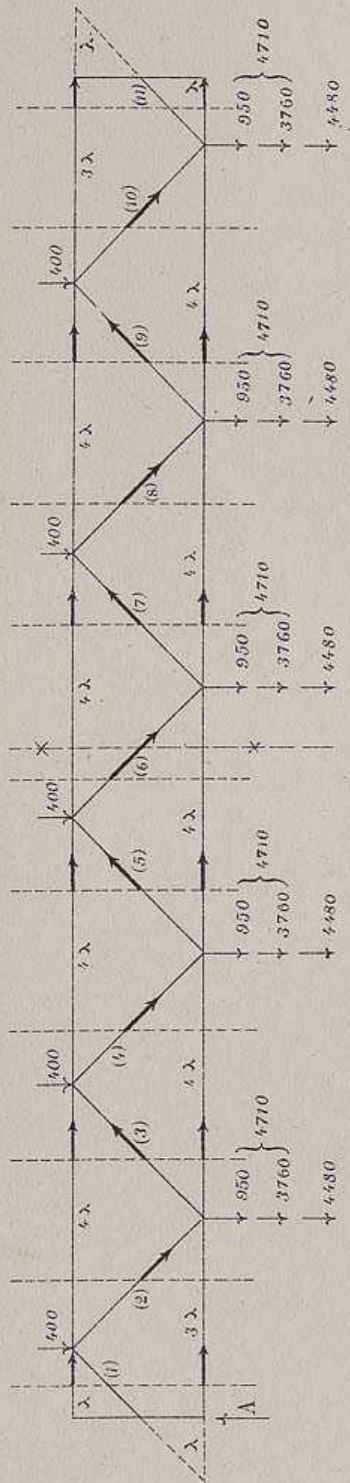

Fig. 393

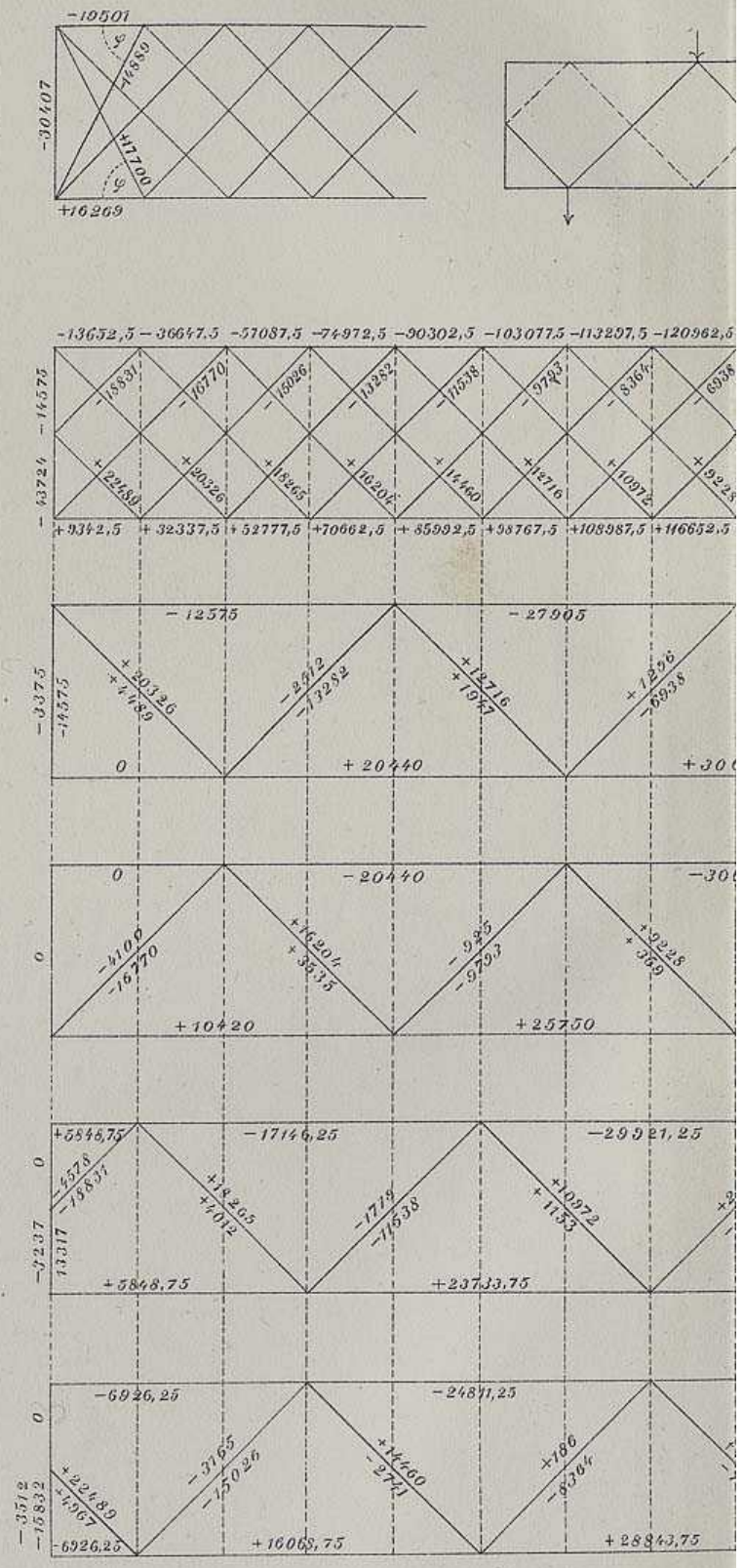



Fig. 391

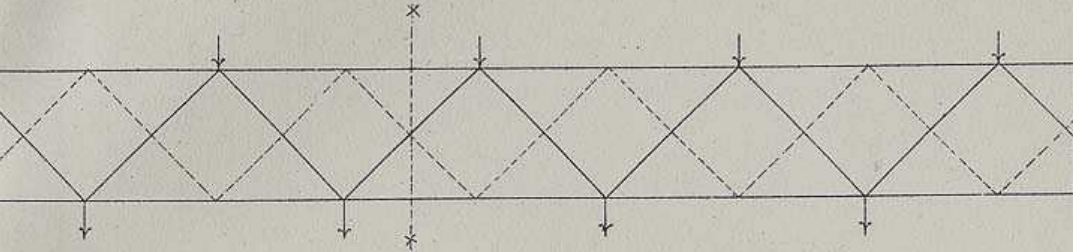

Fig. 392

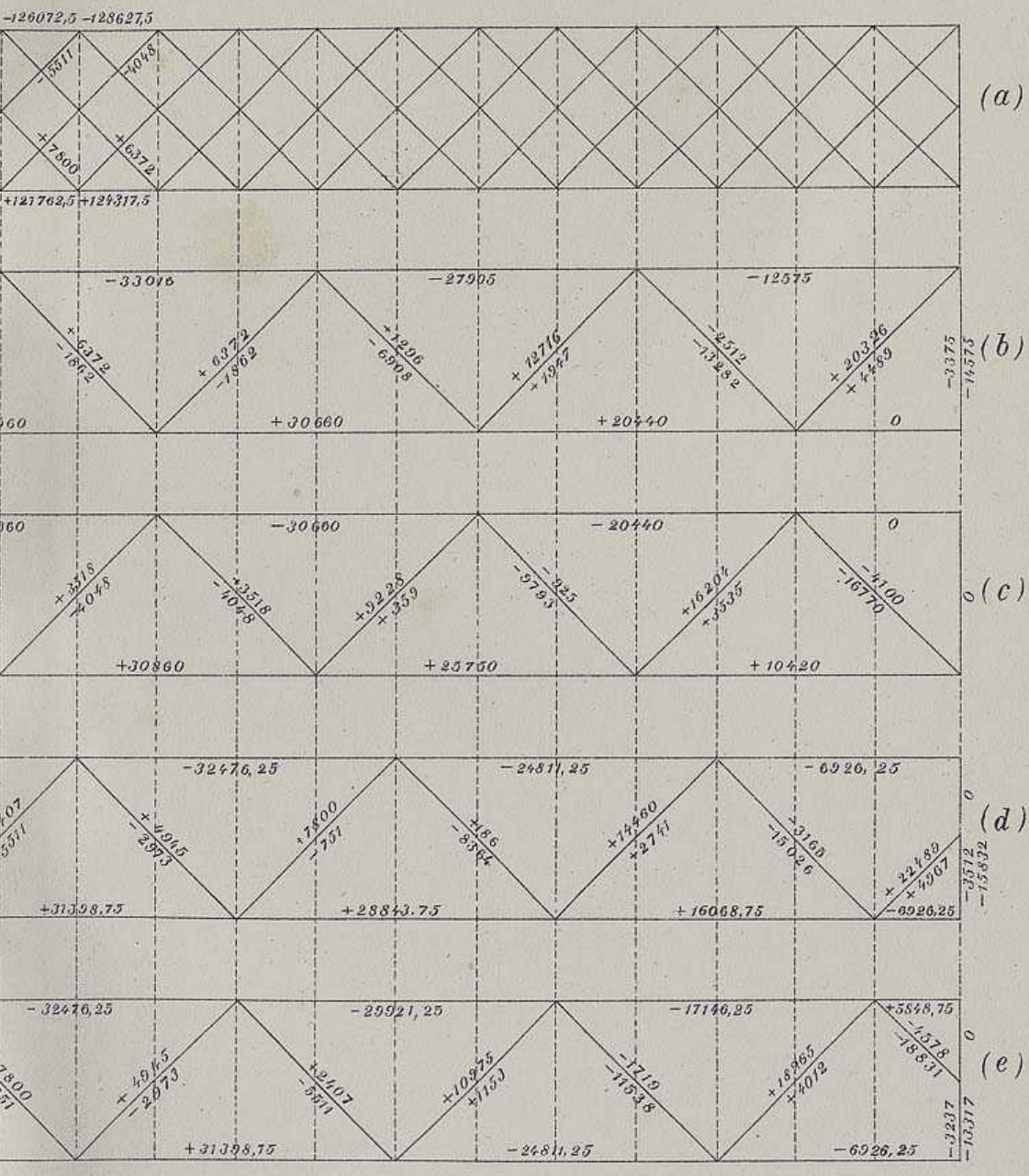



Fig. 394

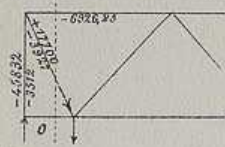

Fig. 395

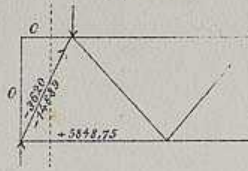

Fig. 396

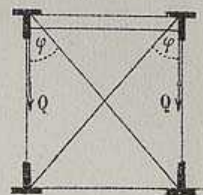

Fig. 397

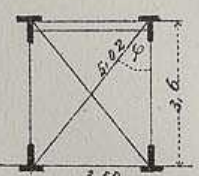

Fig. 400

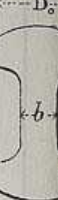

Fig. 399

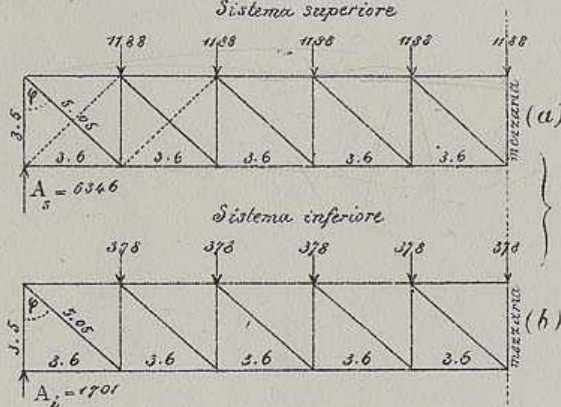

Fig. 398

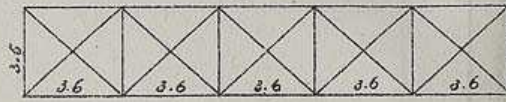

Fig. 403

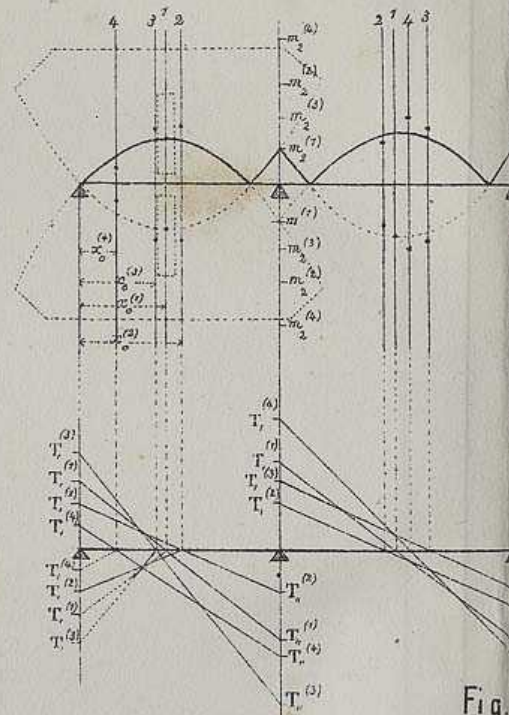

Fig. 401

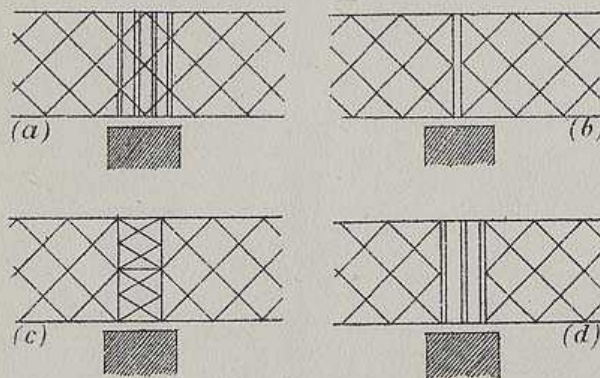
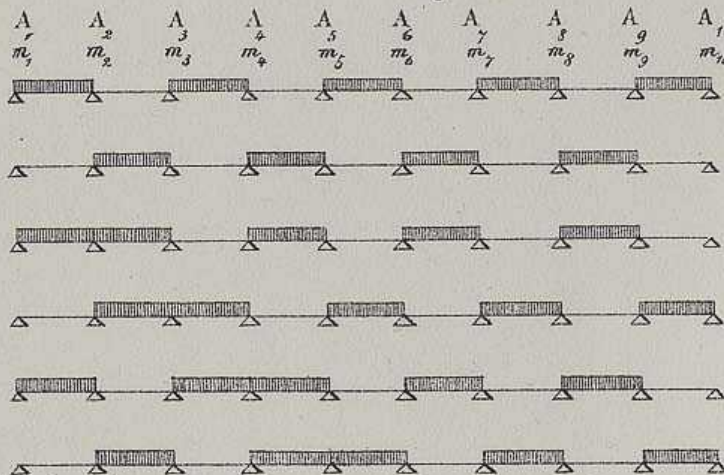

Fig. 402



mas. di  $A_1, A_{10}$  e di  $M_{dispari}$

mas. di  $M_{pari}$

mas. di  $A_2$  ed  $m_2$

mas. di  $A_3$  ed  $m_3$

mas. di  $A_4$  ed  $m_4$

mas. di  $A_5$  ed  $m_5$

Fig.

(a)

(b)



Fig. 405

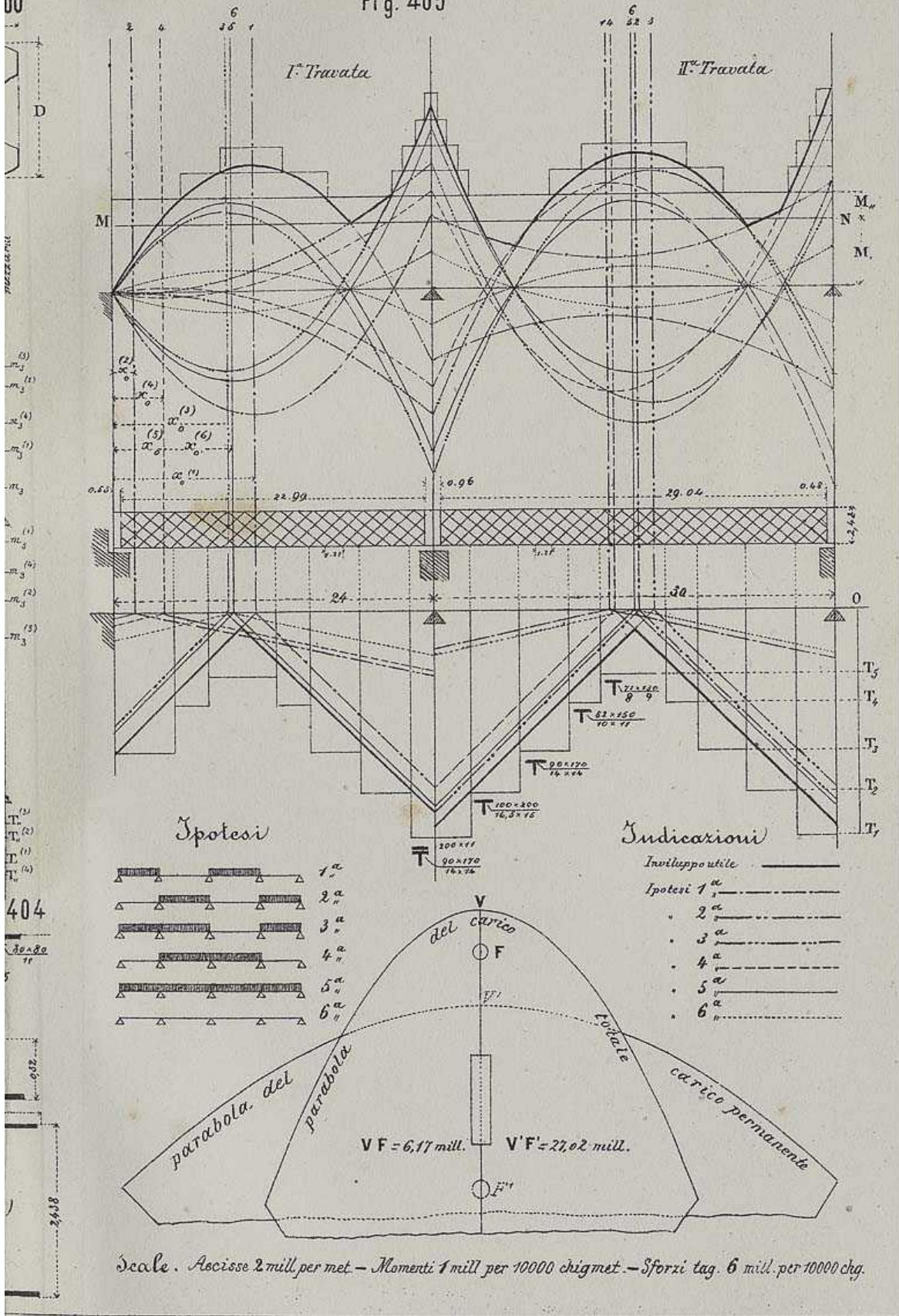







Fig. 408.

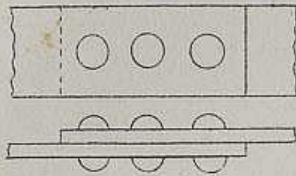

Fig. 411

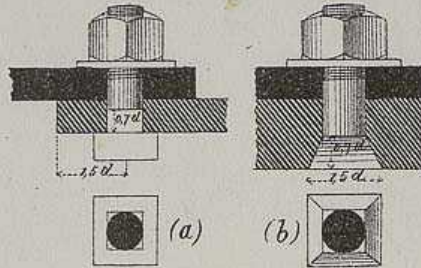

Fig. 414

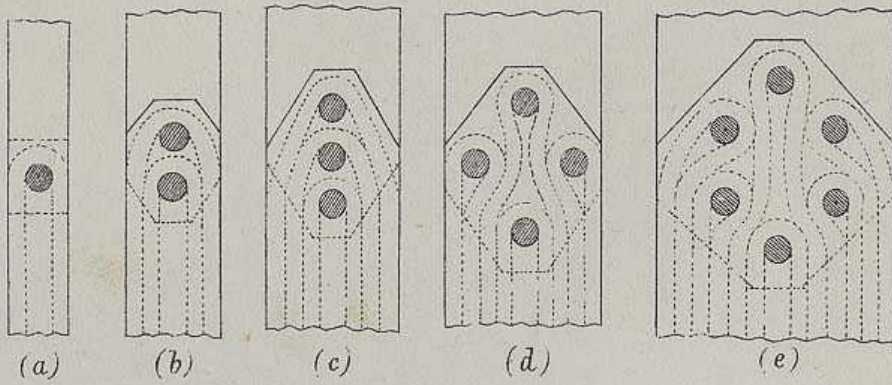

Fig. 417

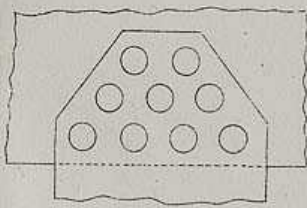

Fig. 420

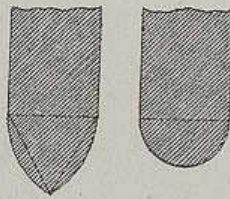

Fig. 421

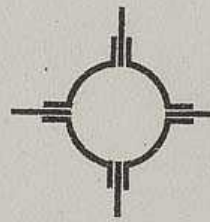

Fig. 419

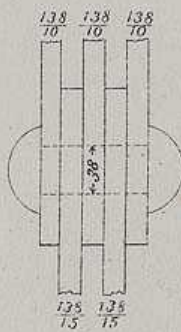
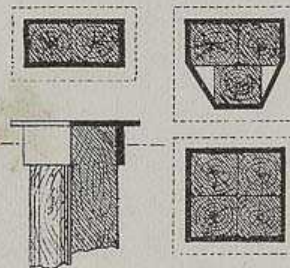

Fig. 422



412

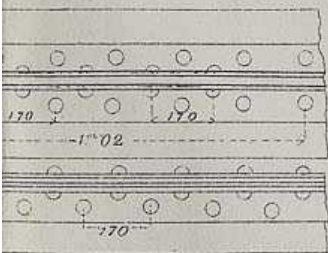



Fig. 423

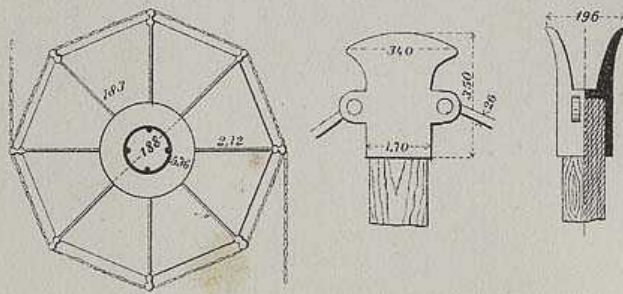

Fig. 424

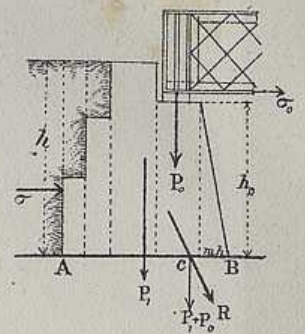

Fig. 427

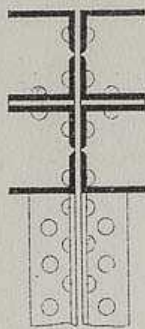

Fig. 428

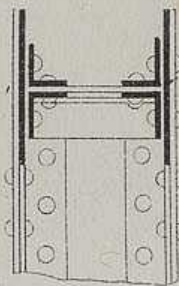

Fig. 429

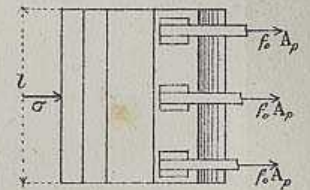
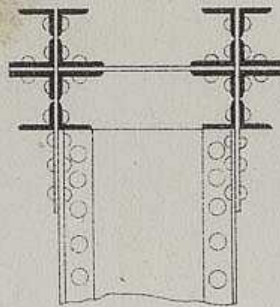

Fig. 431

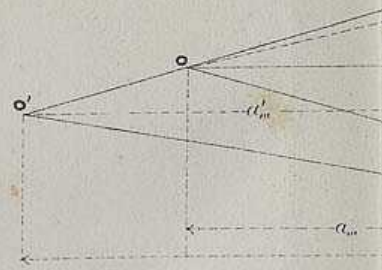
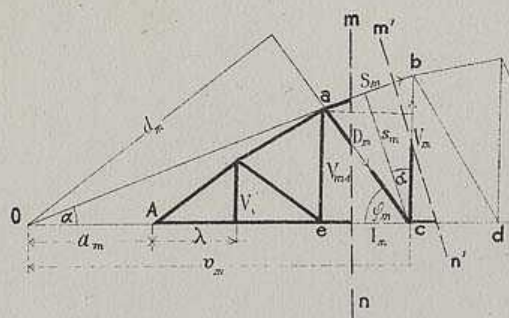

Fig. 435

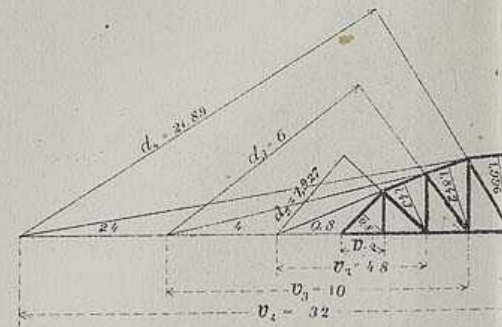
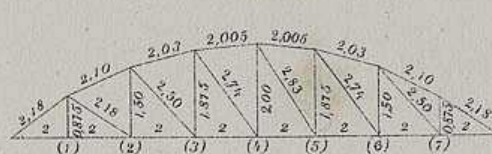







Fig. 438

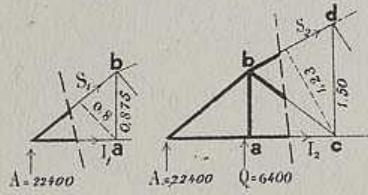

Fig. 439

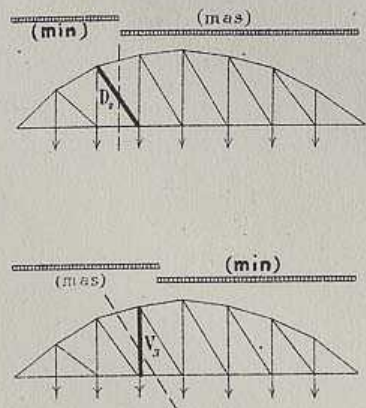

Fig. 442

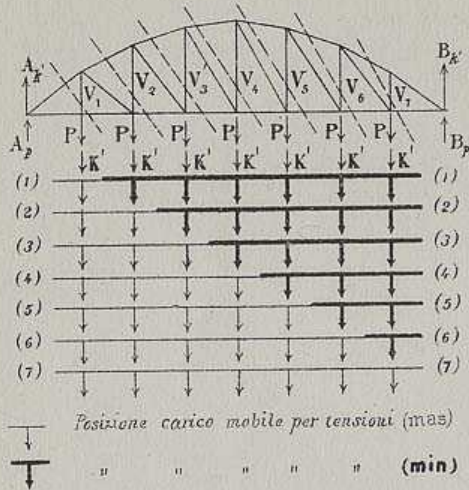

Fig. 444

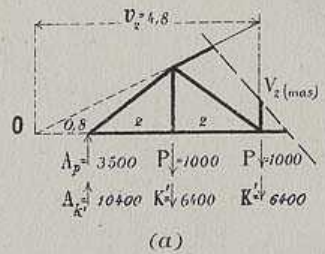

Fig. 445

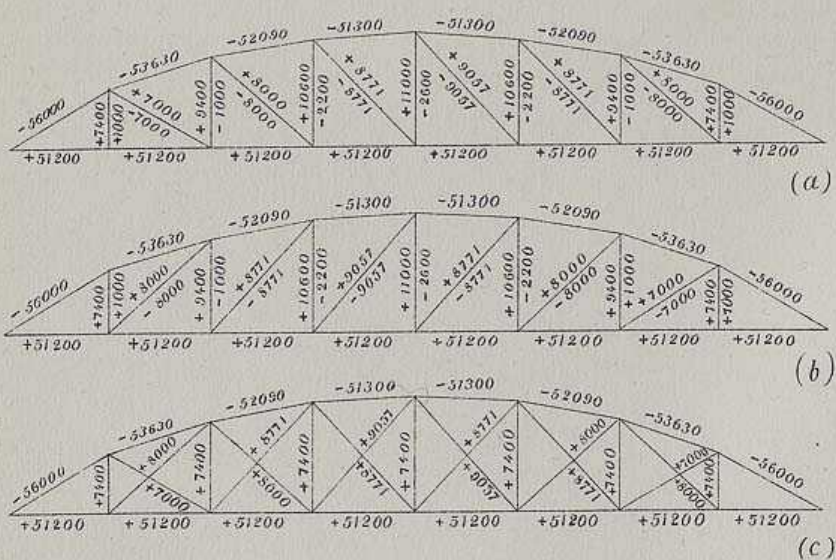
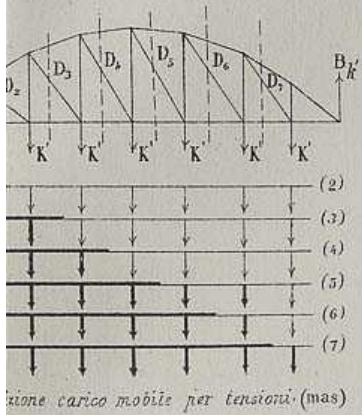



Fig. 440



zione carico mobile per tensioni (mas)

(min)

Fig. 441

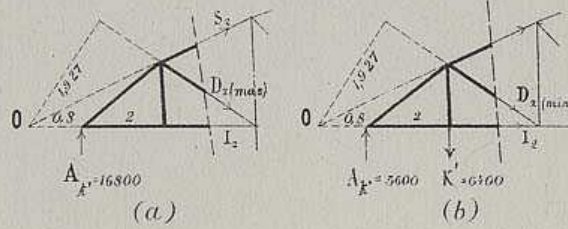
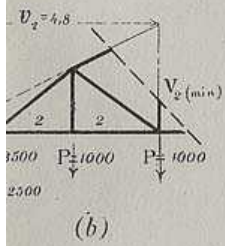
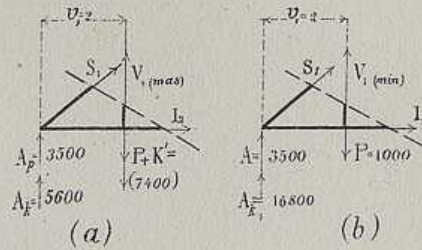

Fig. 443



446

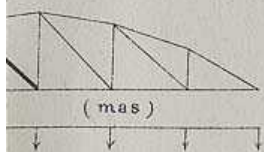

Fig. 448

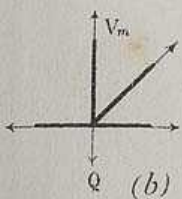

Fig. 447

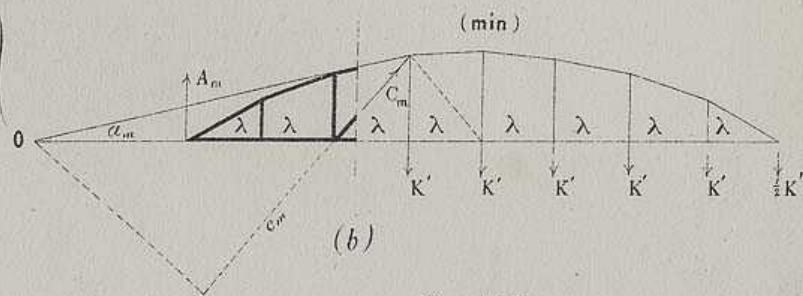
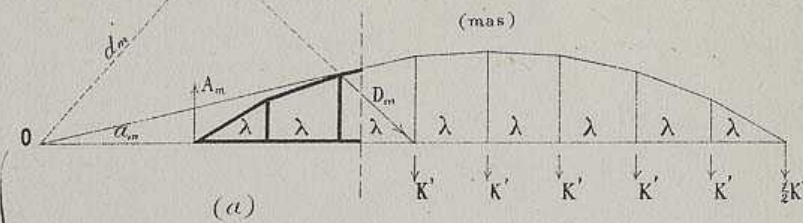

Fig. 449

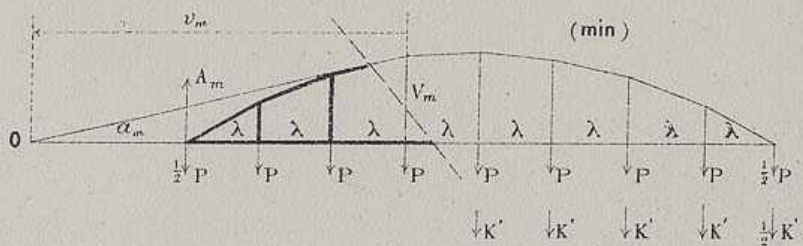







Fig. 451

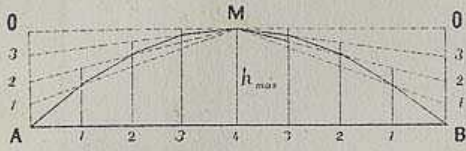

Fig. 452

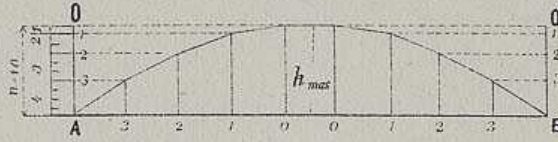

Fig. 455

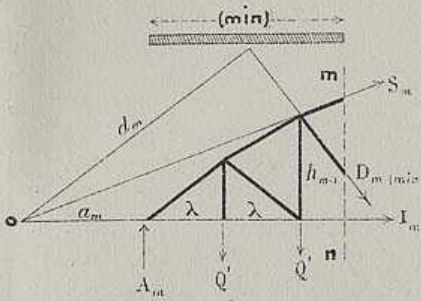

Fig. 456

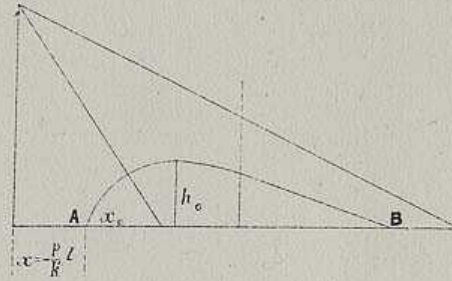

Fig. 459

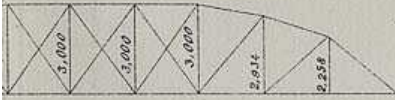

Fig. 463

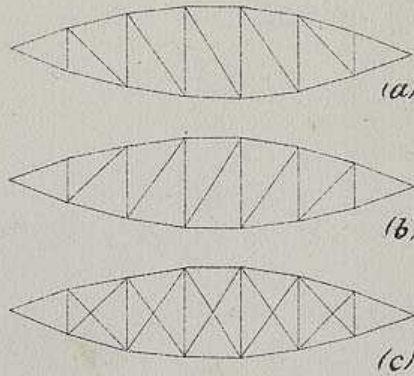

Fig. 461

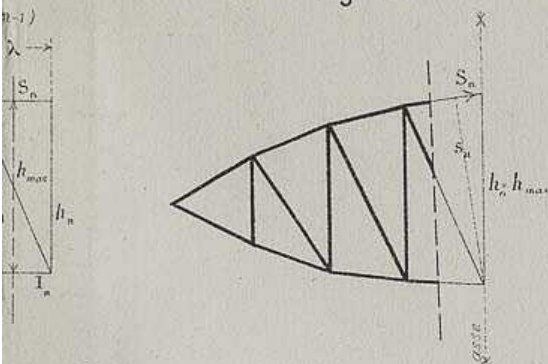

Fig. 464

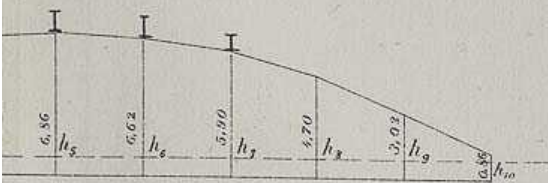

Fig. 465

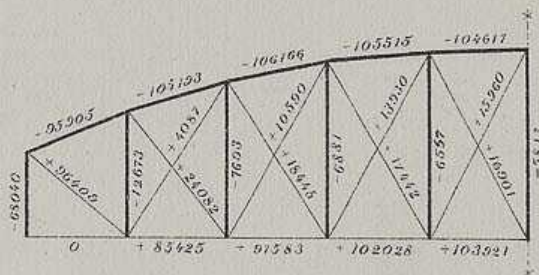



Fig. 467

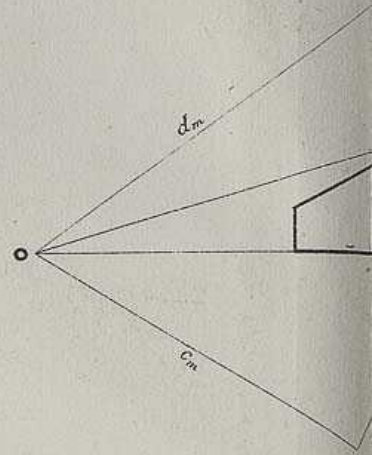
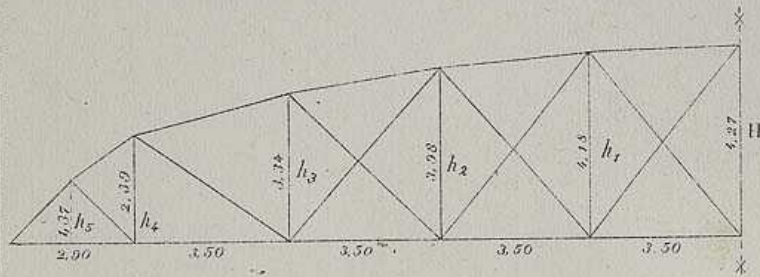

Fig. 471

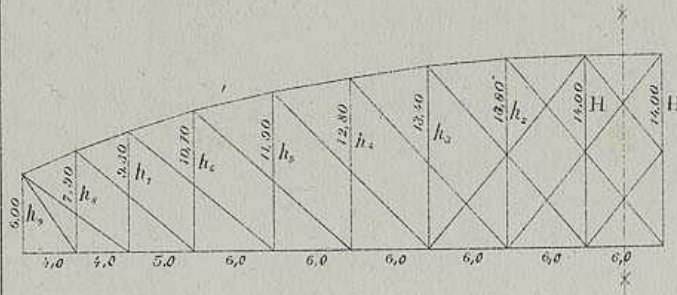

Fig. 468

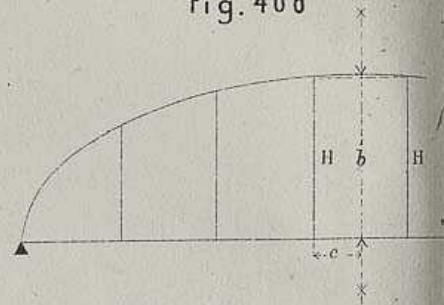

Fig. 469

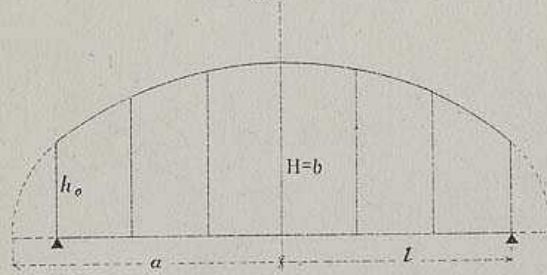

Fig. 470

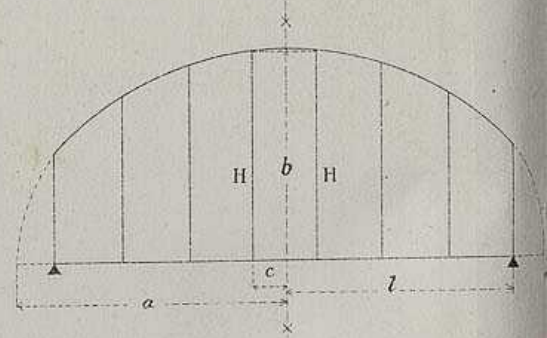

Fig. 472

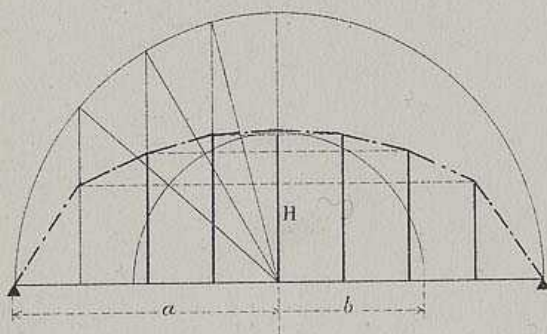

Fig. 473

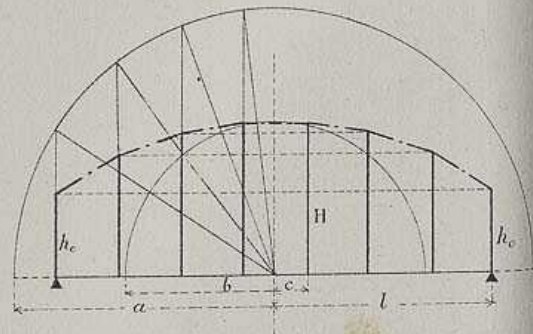







Fig. 476

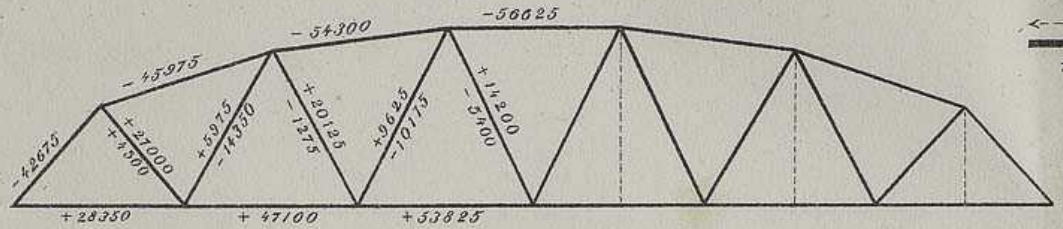

Fig. 477

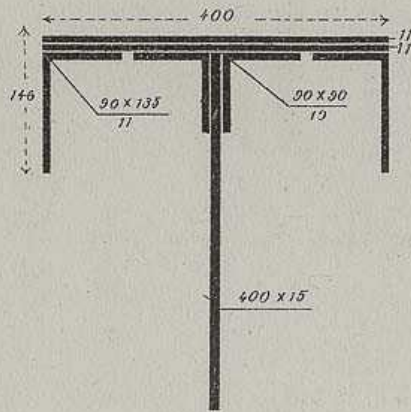

Fig. 485

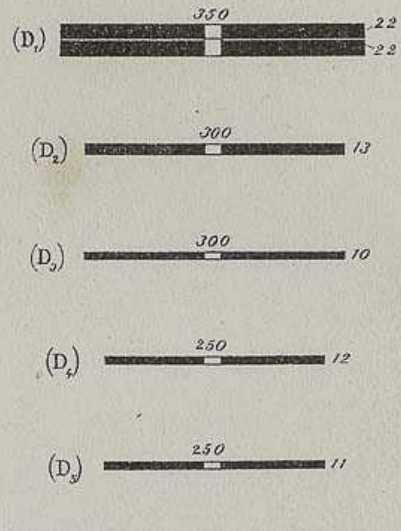

Fig. 485

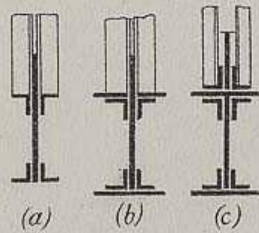

Fig. 486

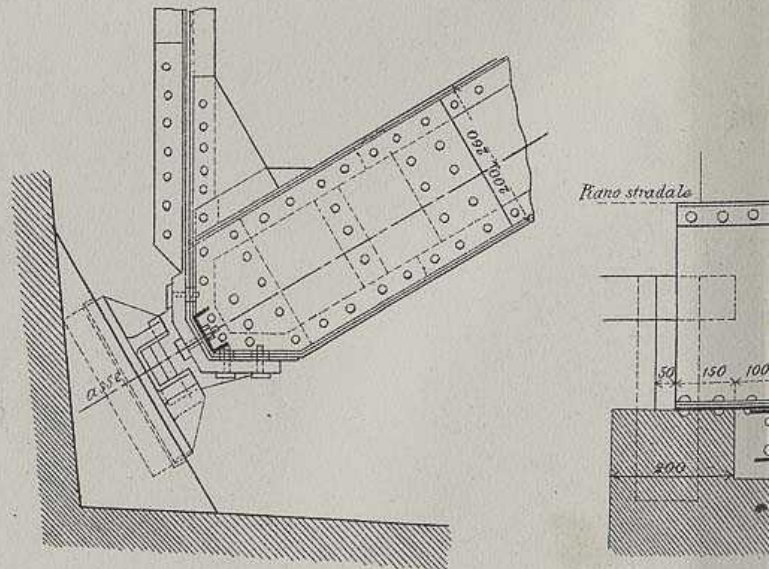

Fig. 487

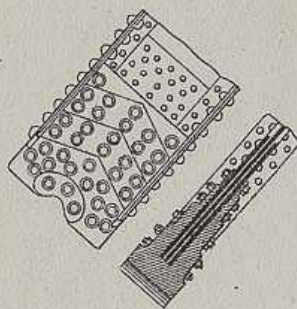



Fig. 478

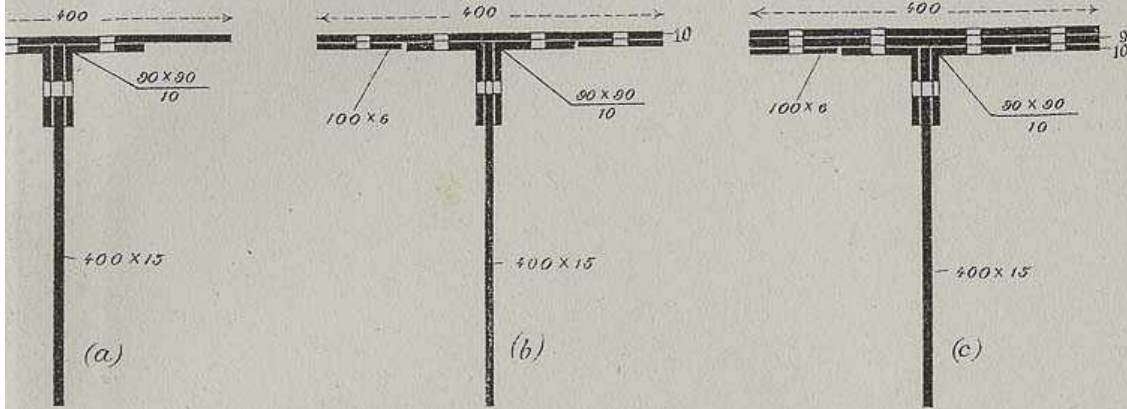

Fig. 480

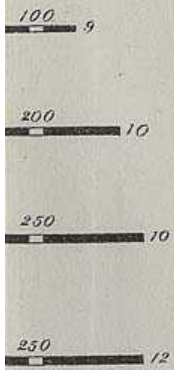

Fig. 481

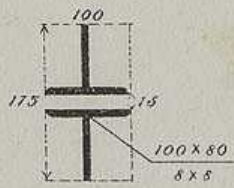

Fig. 482

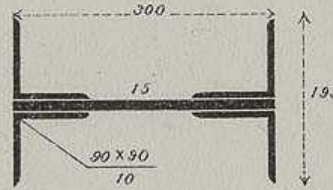

Fig. 483

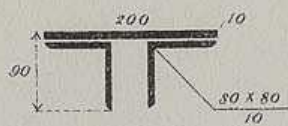

Fig. 484

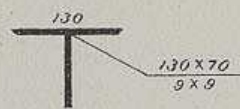

Fig. 488

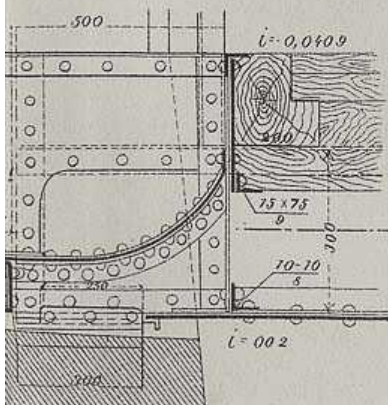

Fig. 489

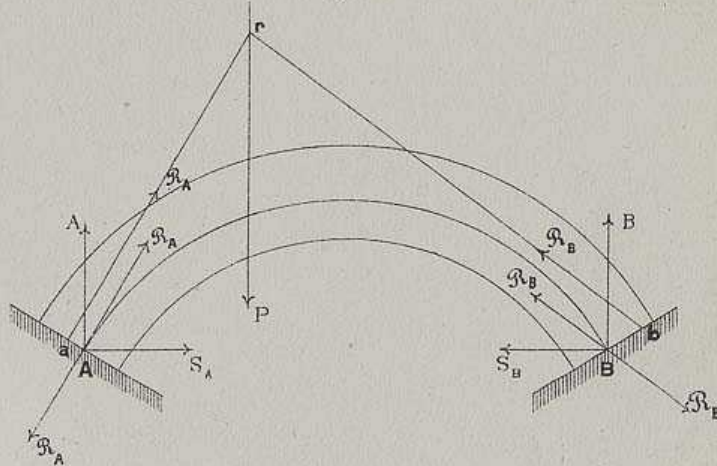



Fig. 490

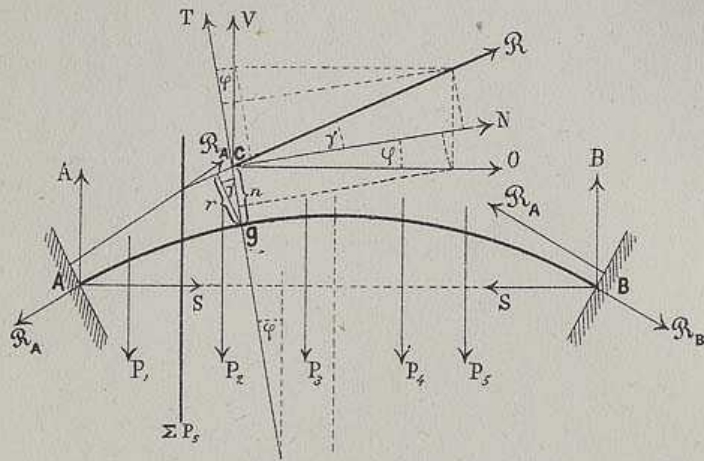

Fig.

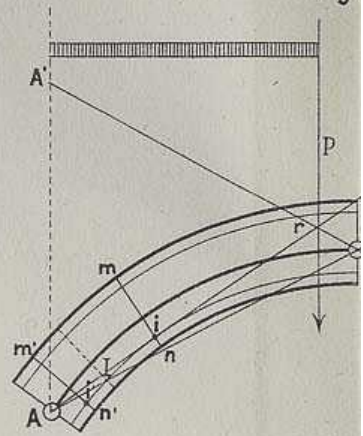

Fig. 492

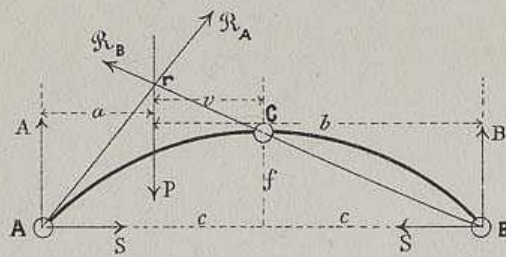

Fig. 491

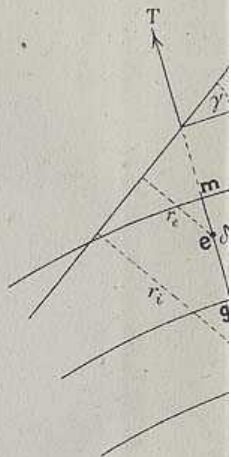

Fig. 493

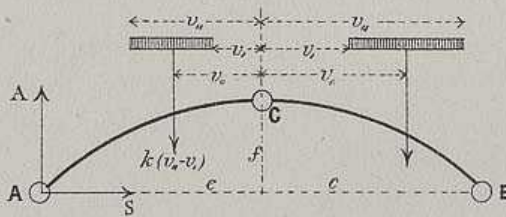

Fig. 492

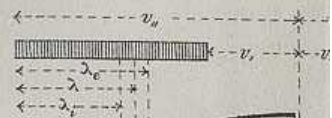
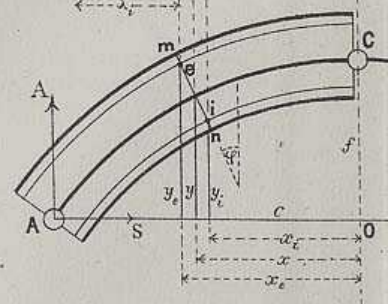
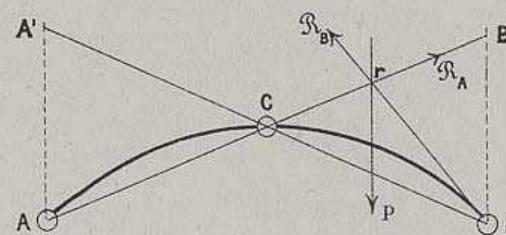

Fig. 494





496

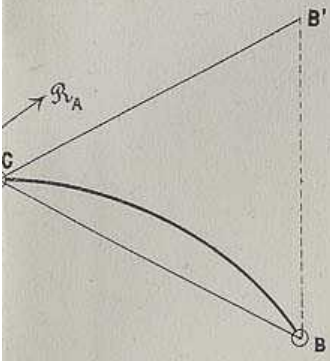
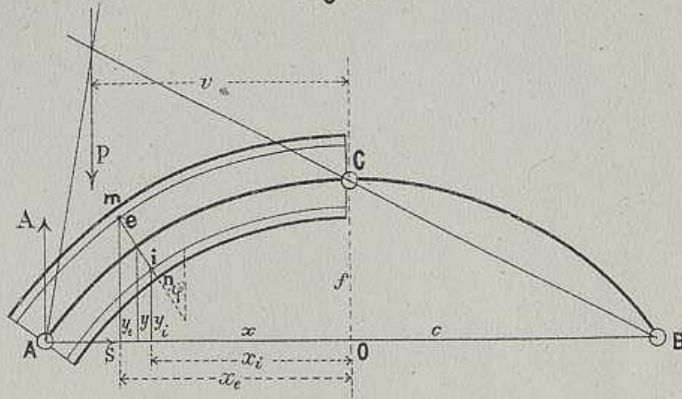

Fig. 497



91

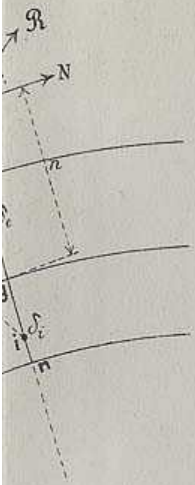
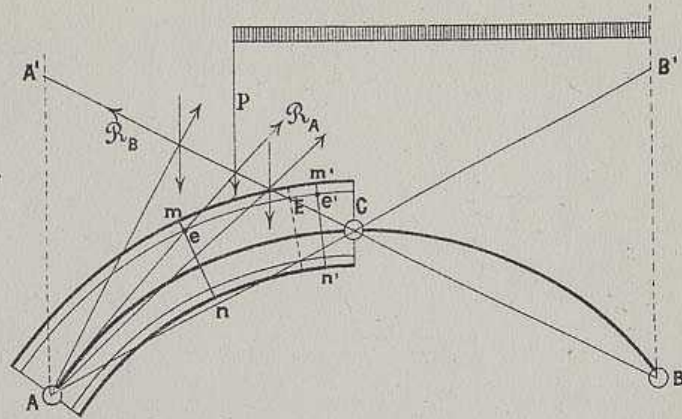

Fig. 495



8

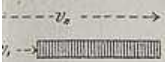

Fig. 499

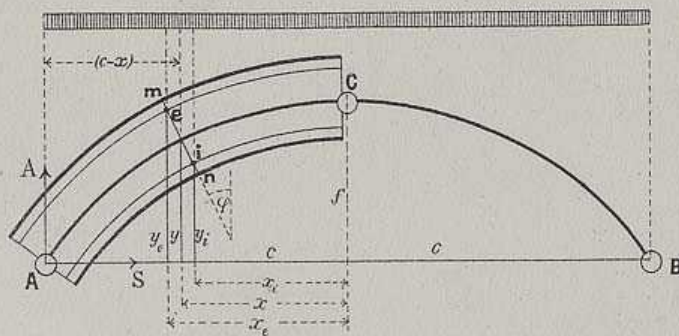



Fig. 500

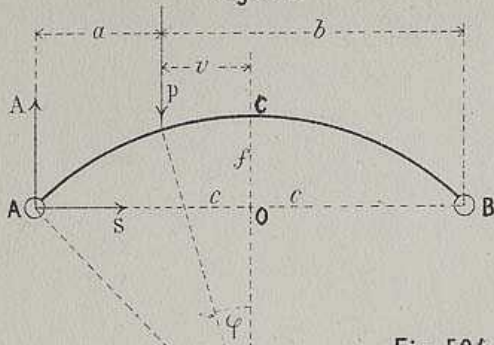

Fig. 501

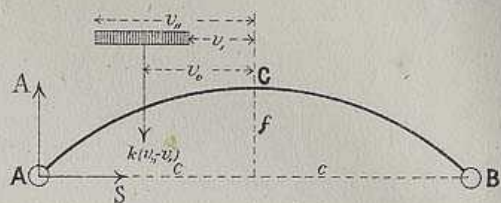

Fig. 504

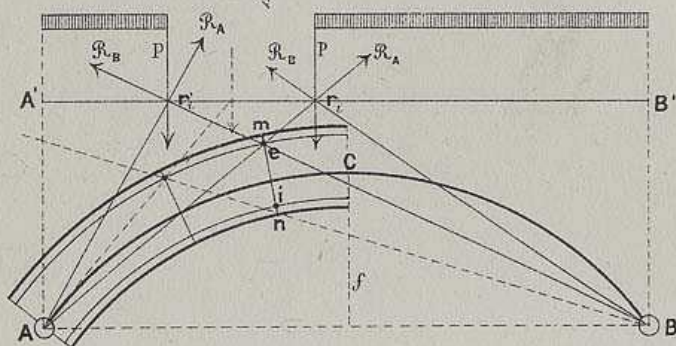

Fig. 505

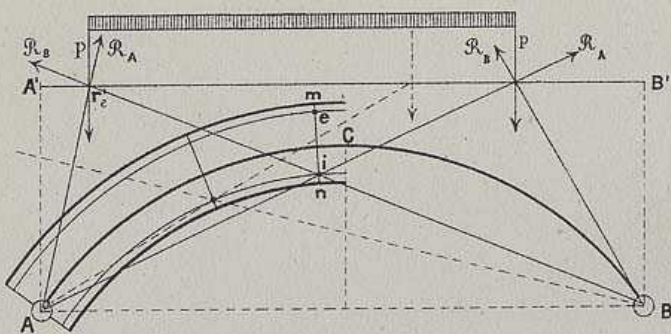

Fig. 509

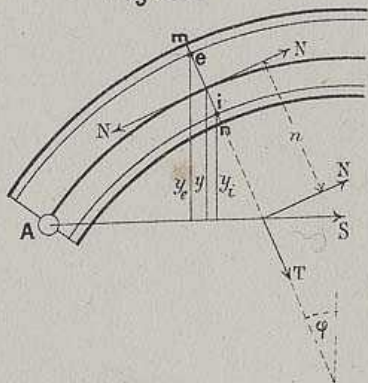

Fig. 511

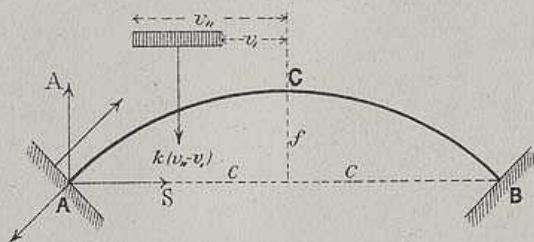



Fig. 502

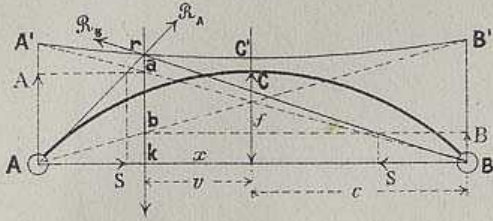

Fig. 503

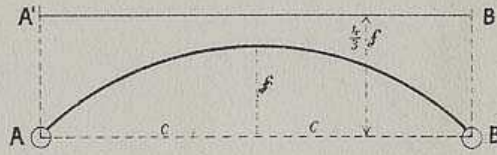

Fig. 506

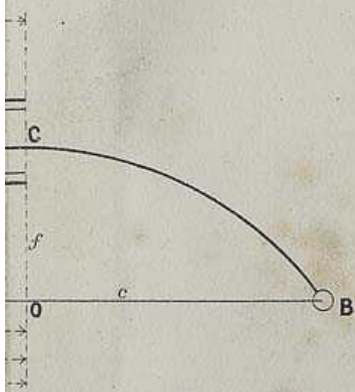
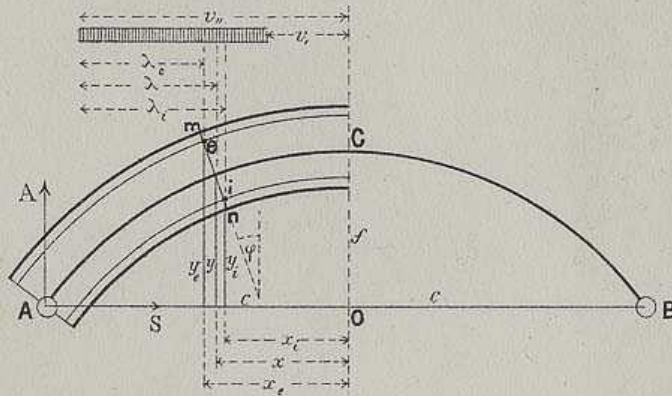

Fig. 507



508

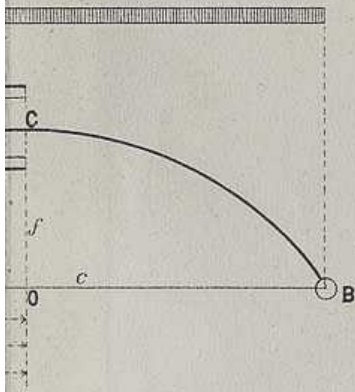

Fig. 510

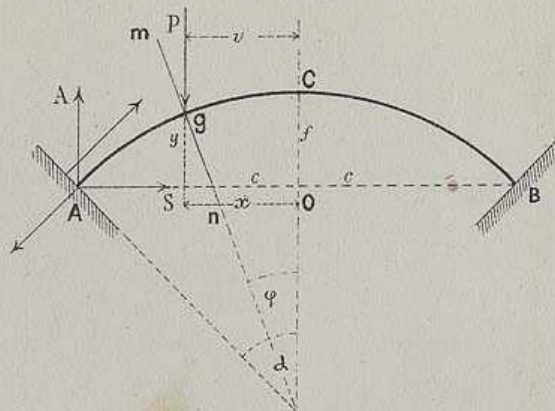

Fig. 512

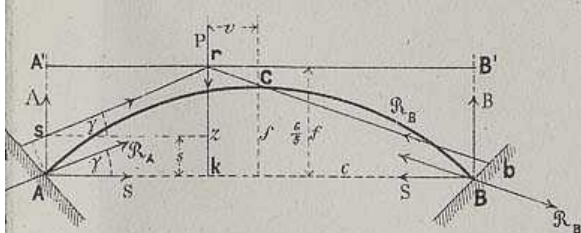

Fig. 513

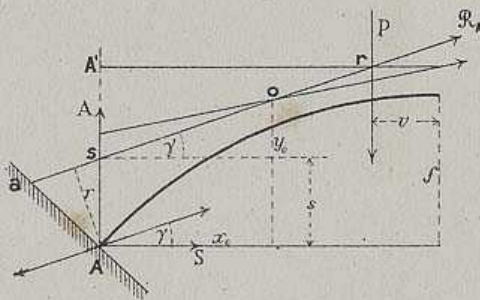



Fig 514

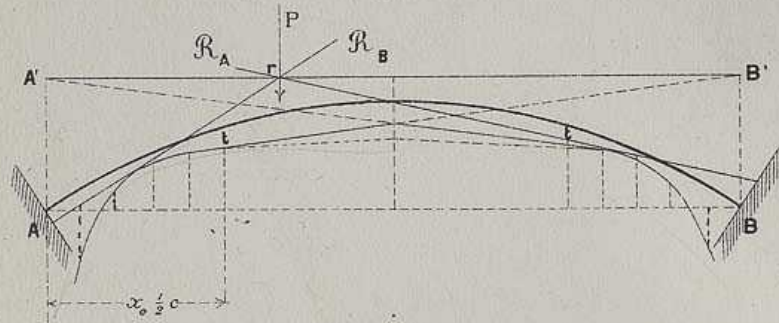

Fig 517

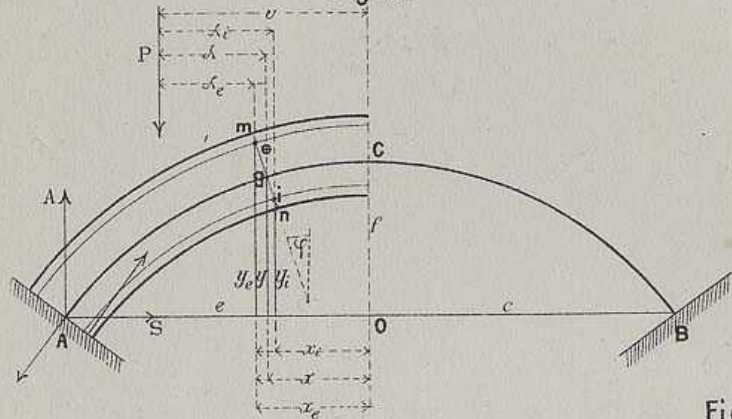
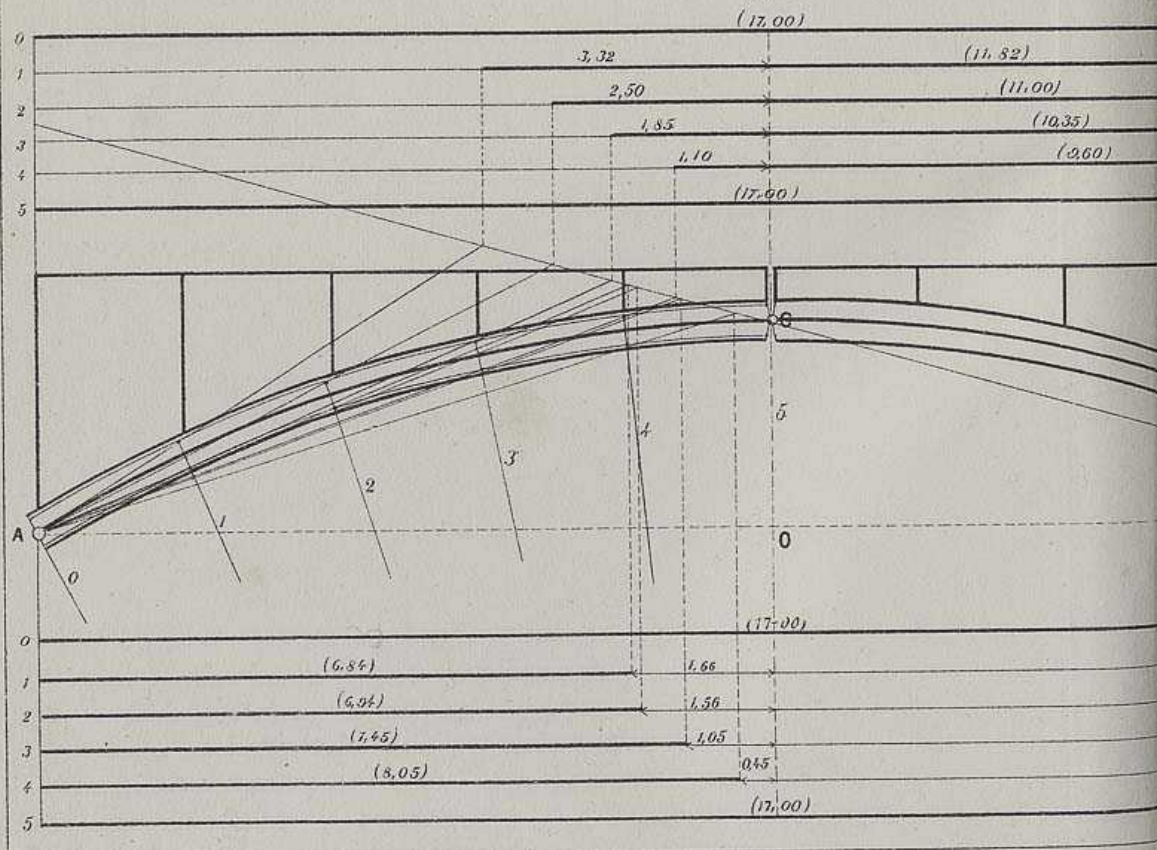
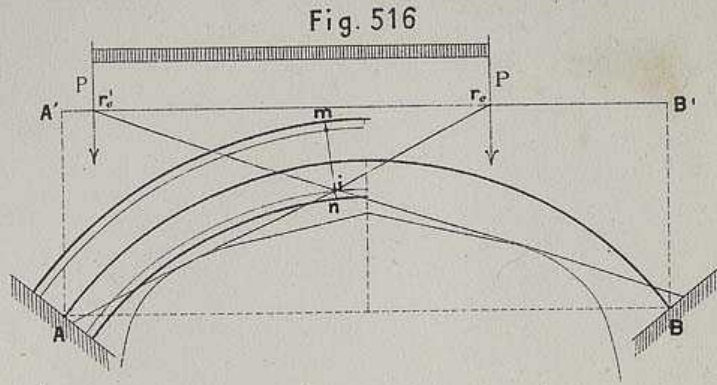
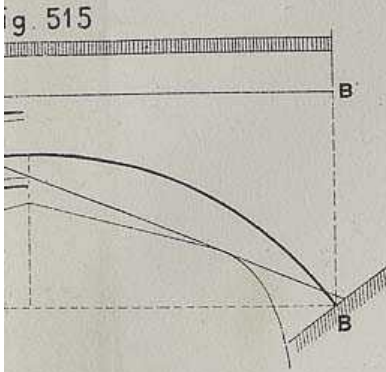

Fig. 521







518

Fig. 520

Fig. 523

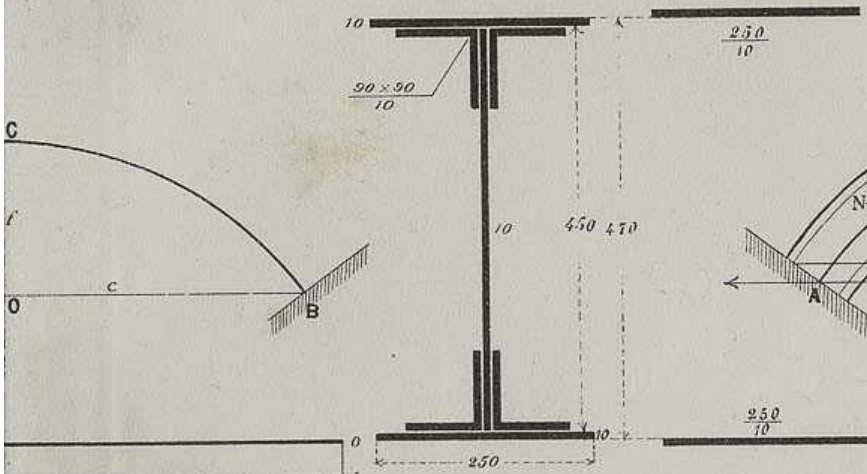

Fig. 519

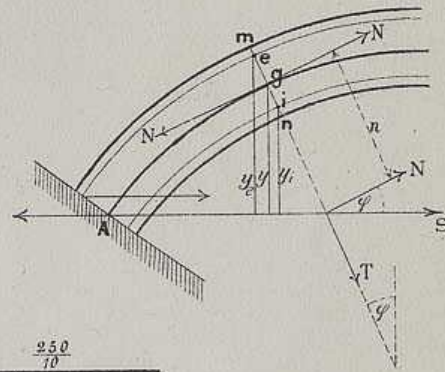
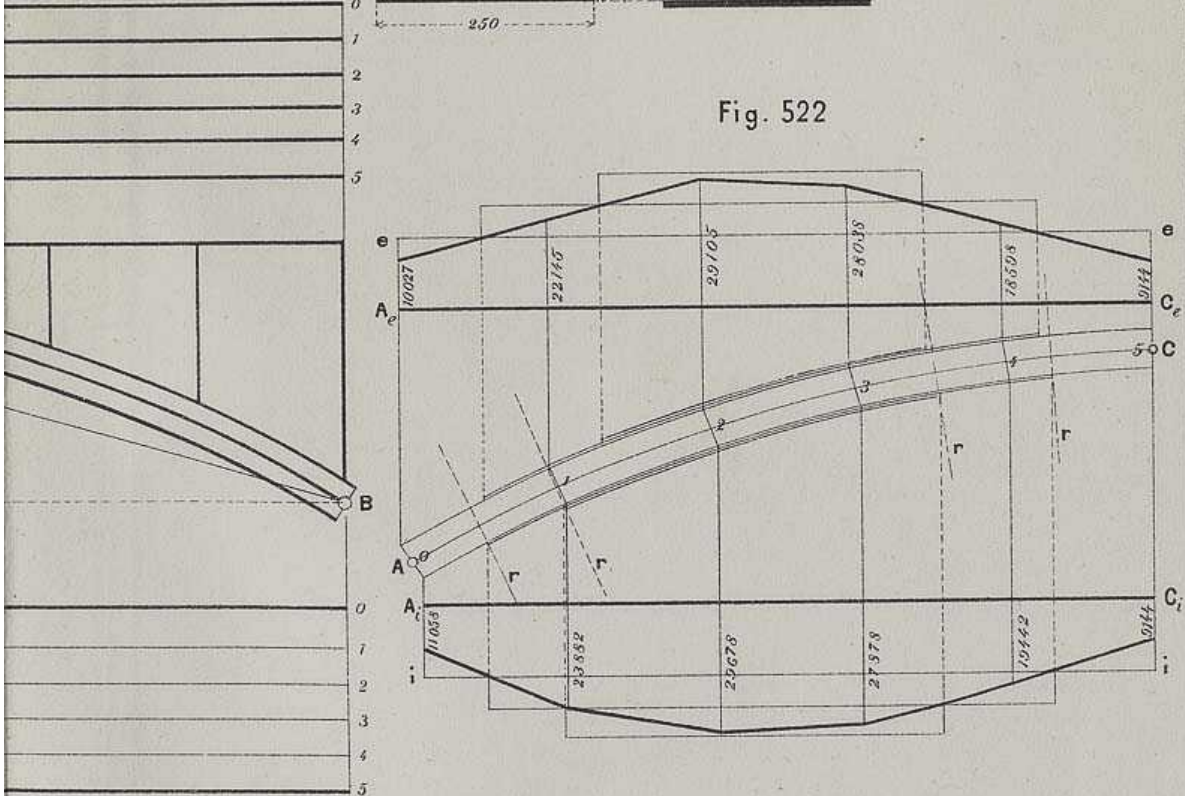

Fig. 522









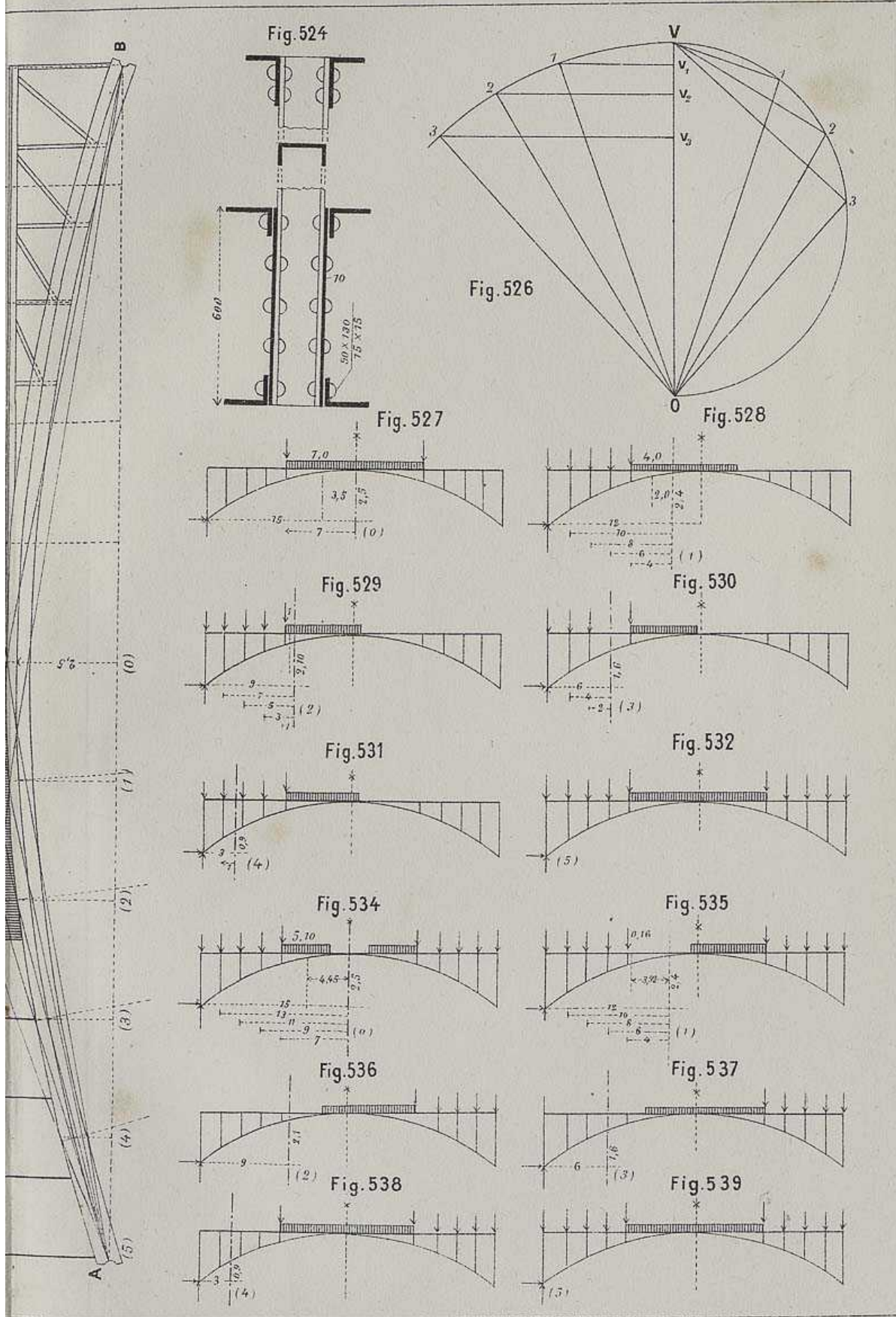



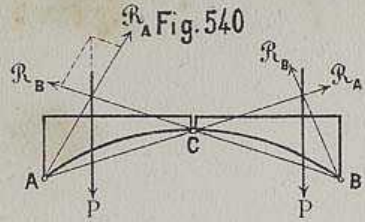

Fig. 541

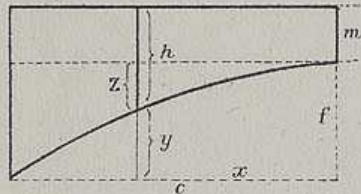

Fig. 542

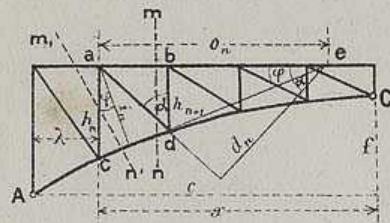

Fig. 545

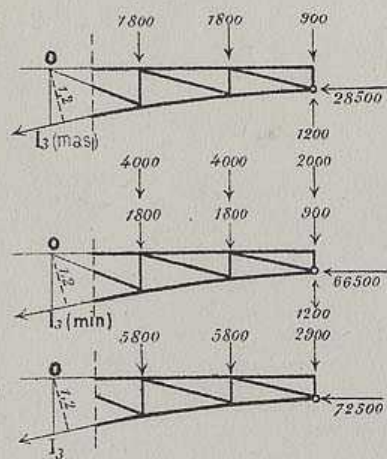

Fig. 552

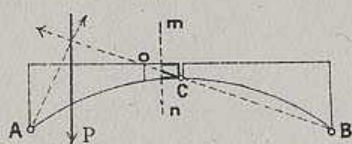

Fig. 543

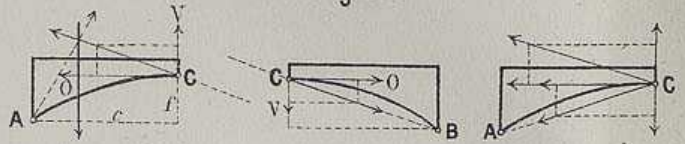

Fig. 544

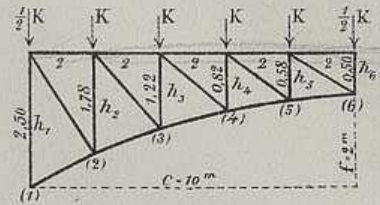

Fig. 545

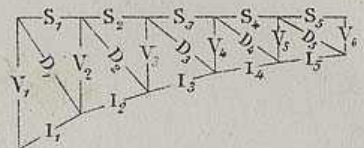

Fig. 553

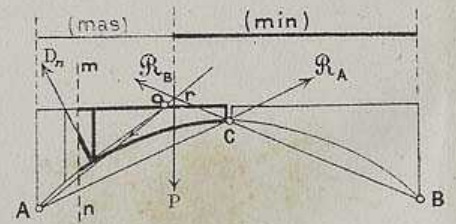

Fig. 555

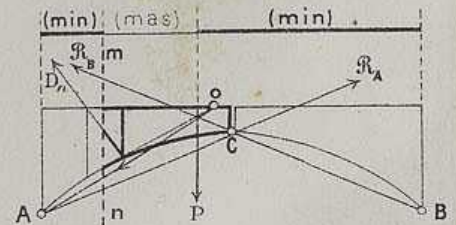

Fig. 556

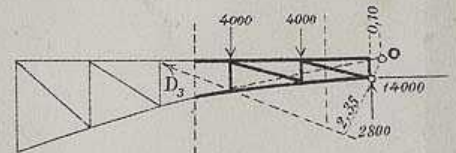



Fig. 546

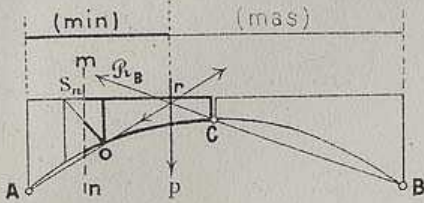

Fig. 547

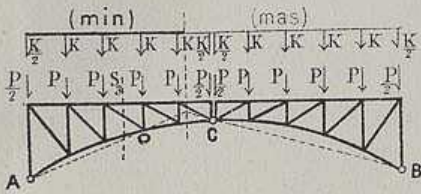

Fig. 549

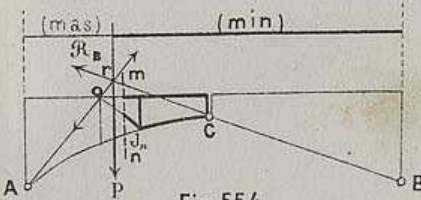

Fig. 554

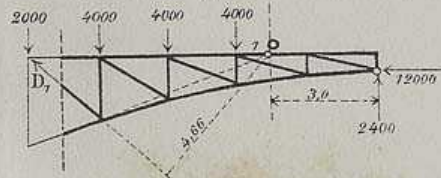

Fig. 557

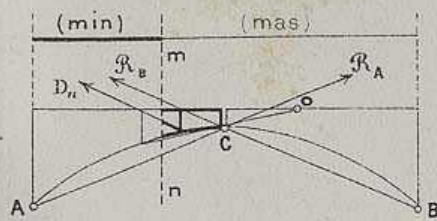

Fig. 558

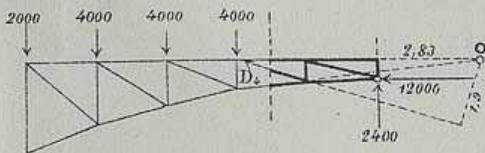

Fig. 548

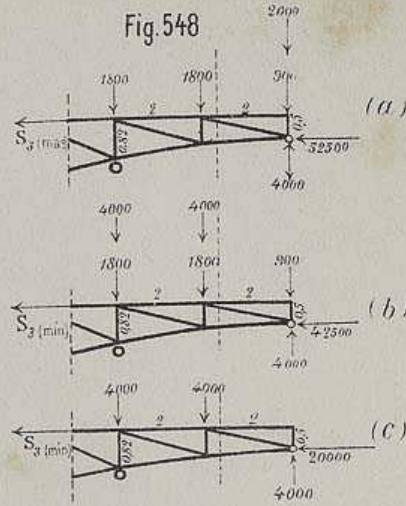

Fig. 550

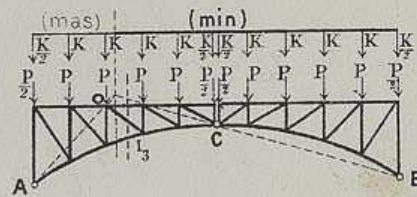

Fig. 559

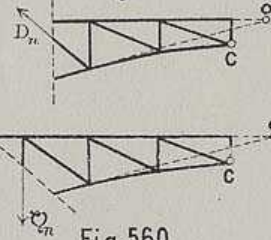

Fig. 560

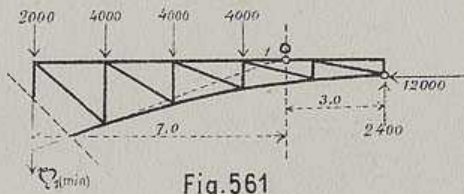

Fig. 561

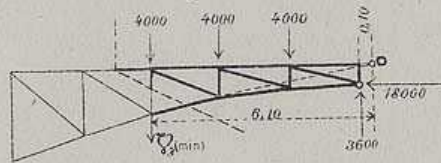

Fig. 562

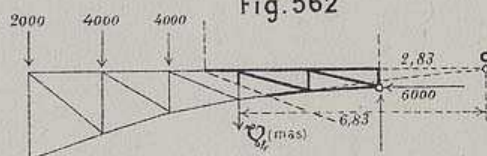



Fig. 563

Sbarre della nervatura superiore (S)

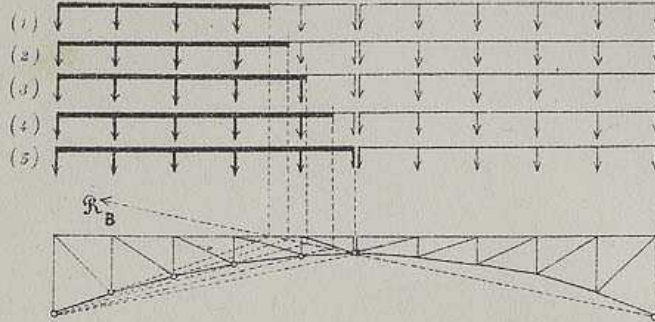

Fig. 564

Sbarre della nervatura inferiore

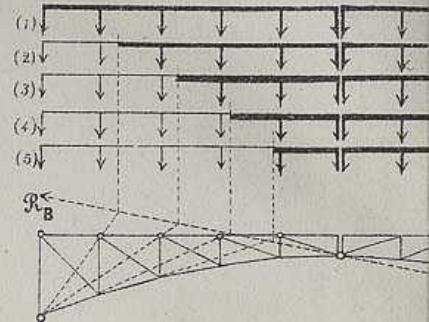
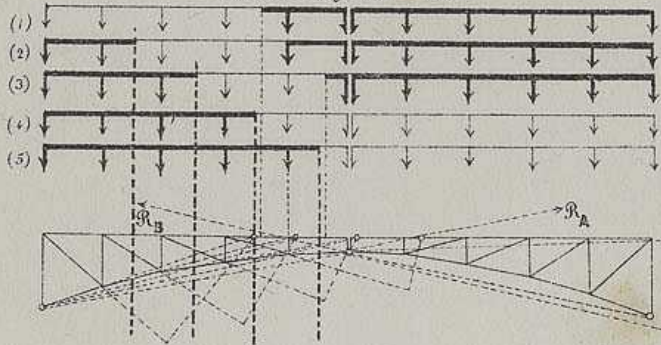

Fig. 565

Sbarre diagonali (D)



Scala mill. 1:5 per metro

Fig. 566

Sbarre verticali (V)

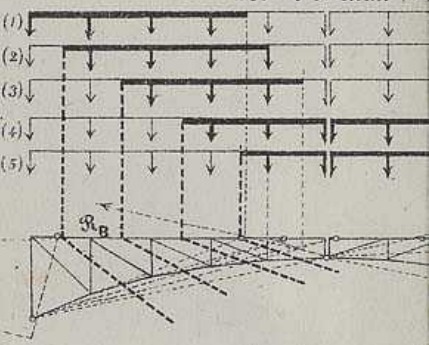

Posizione del carico mobile per tensioni (min)

Posizione del carico mobile

Fig. 568

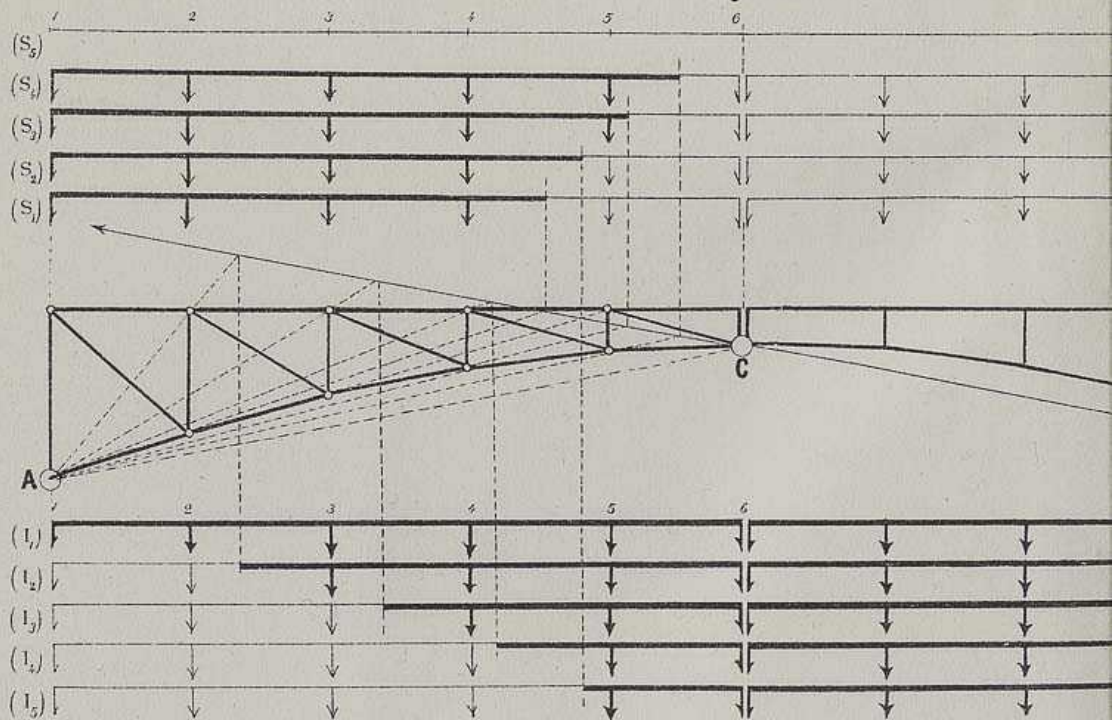



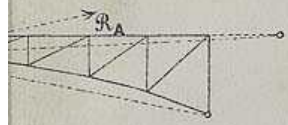
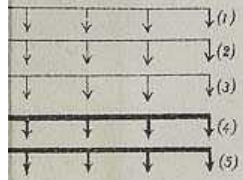
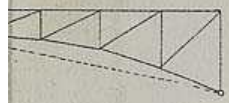
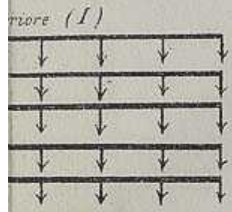

per tensioni (mas)

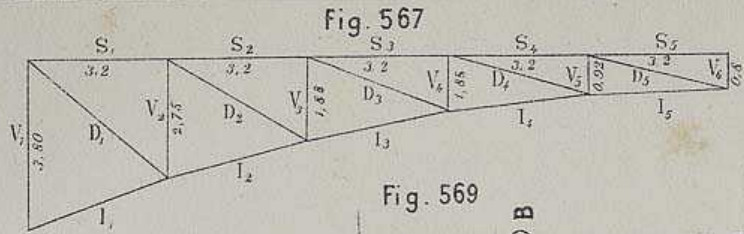
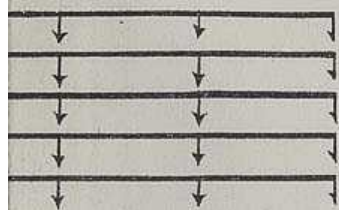
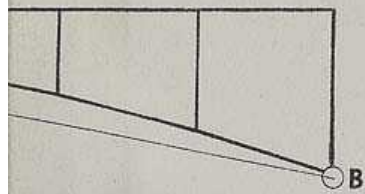
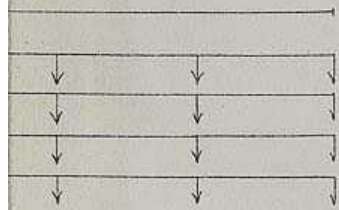
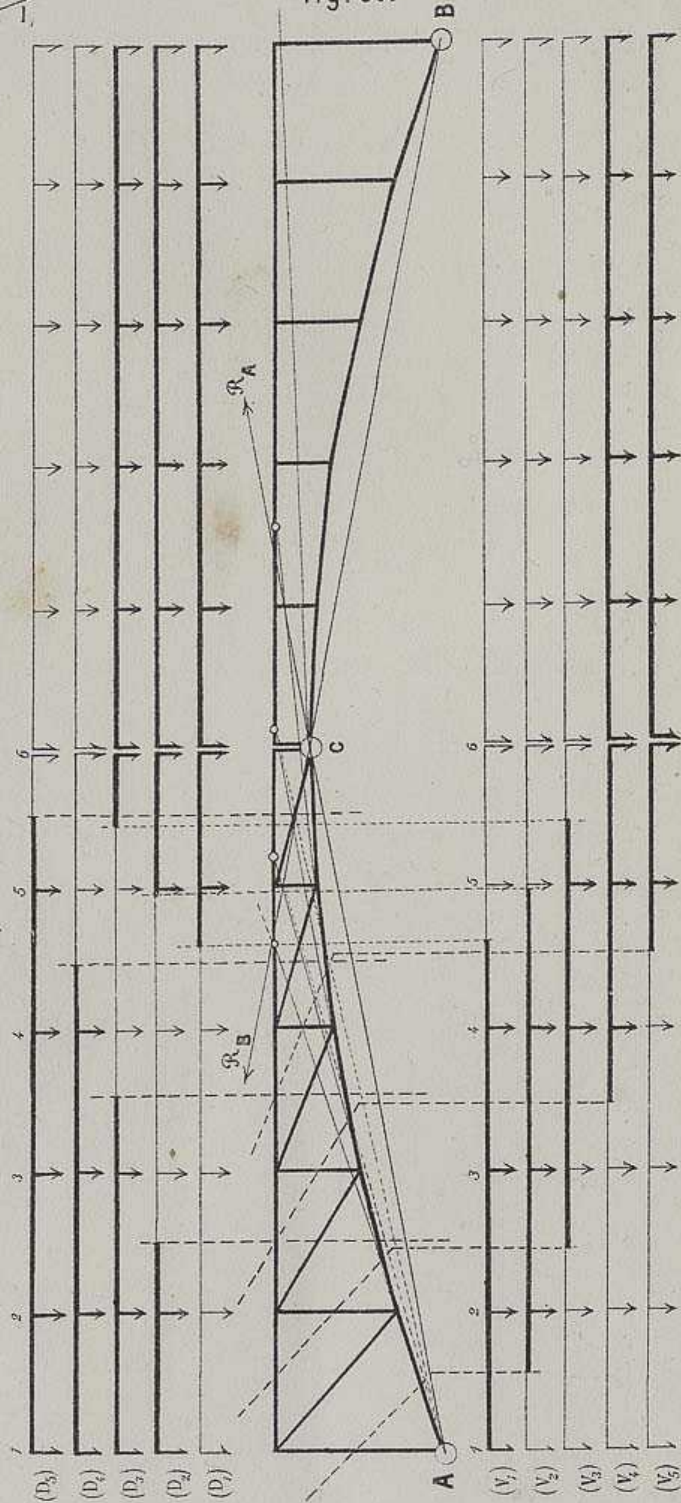

Fig. 569





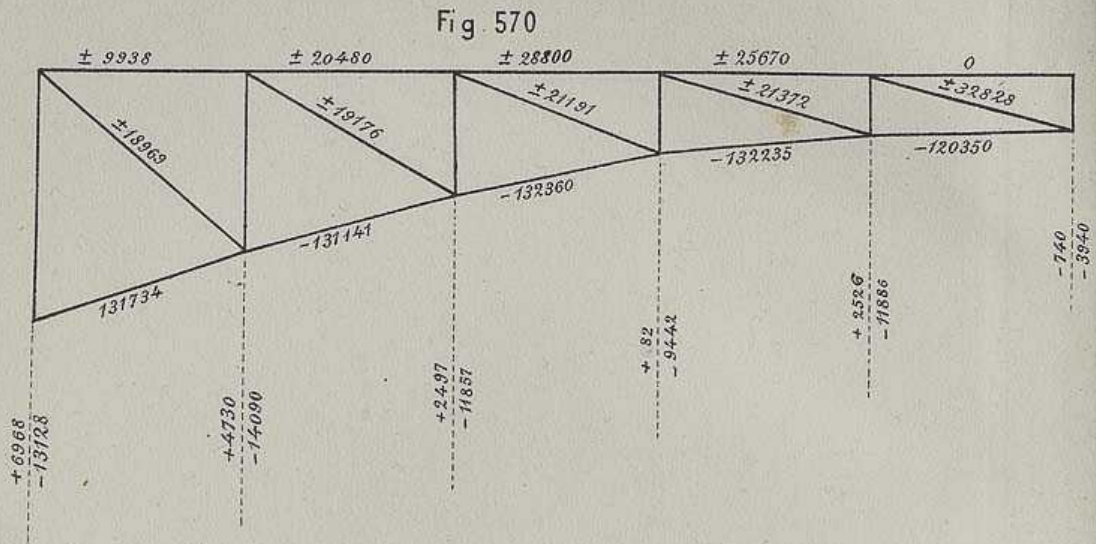

Fig. 571

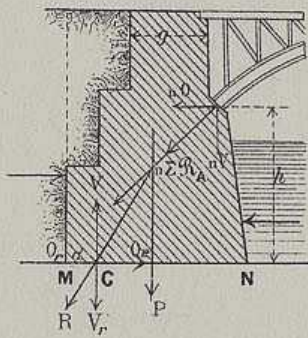

Fig. 574

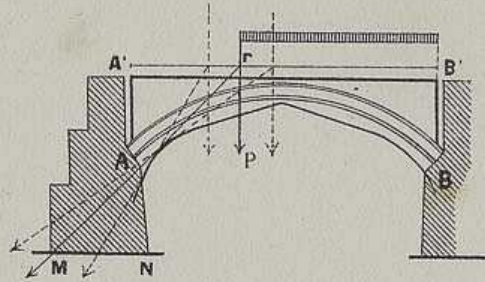

Fig. 575

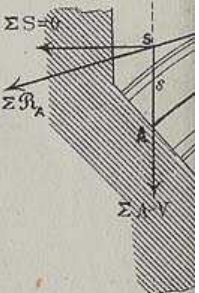

Fig. 576

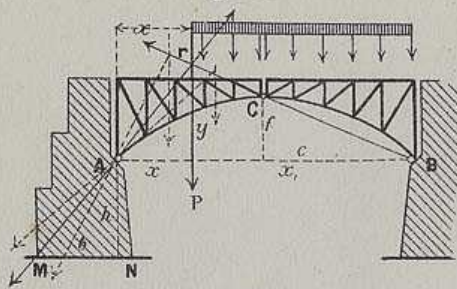

Fig. 577

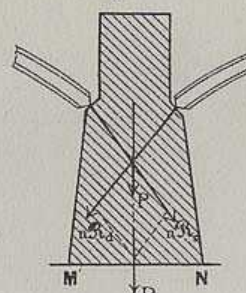

Fig. 578

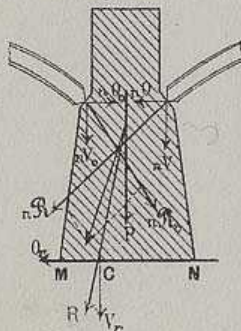

Fig. 579

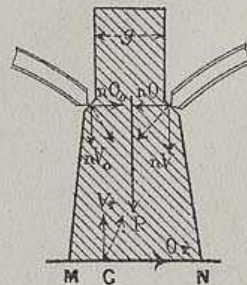

Fig. 581

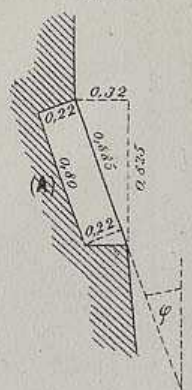



Fig. 572

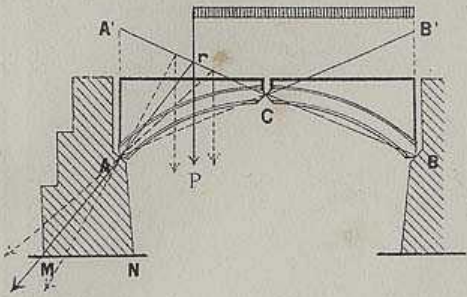

Fig 573

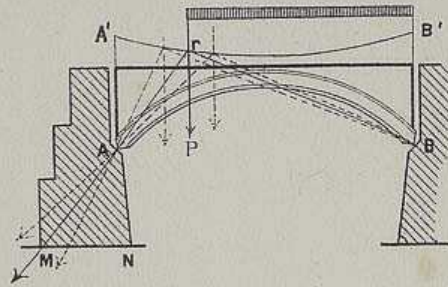

Fig. 580

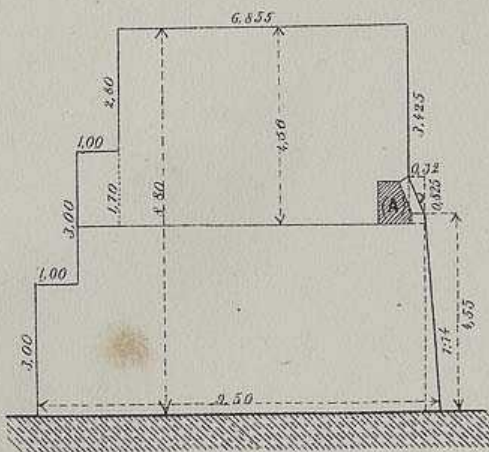

Fig 583

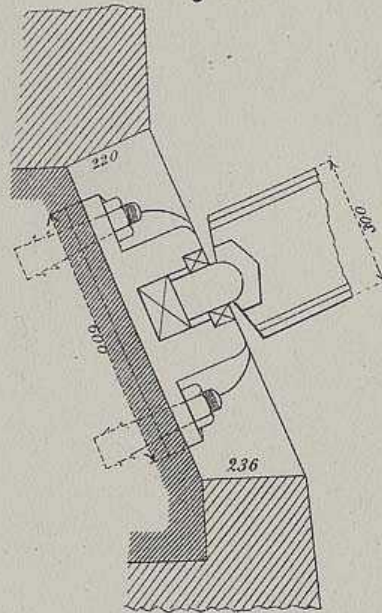

Fig. 584

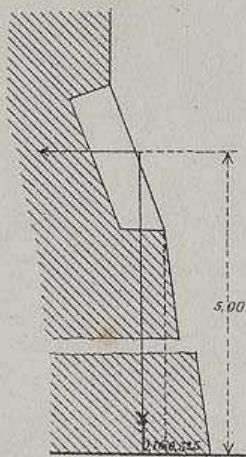

Fig. 582



Fig. 585

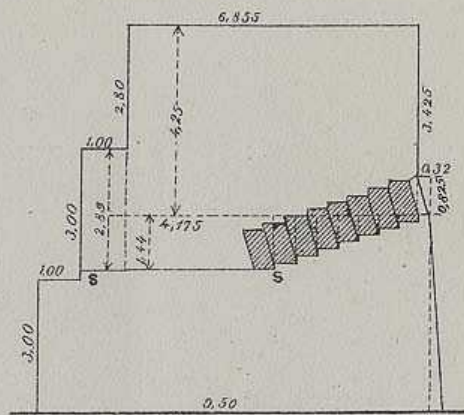



Fig. 586

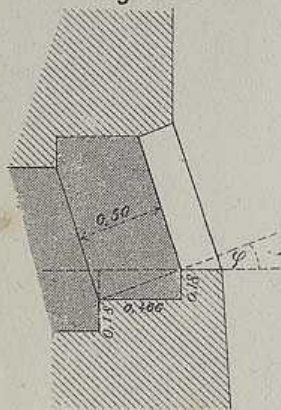

Fig. 590

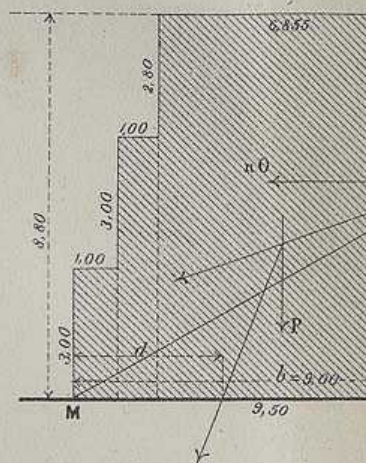
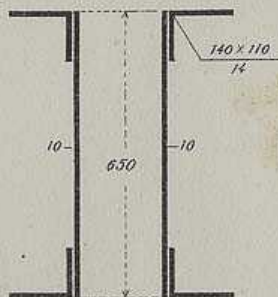

Fig. 589

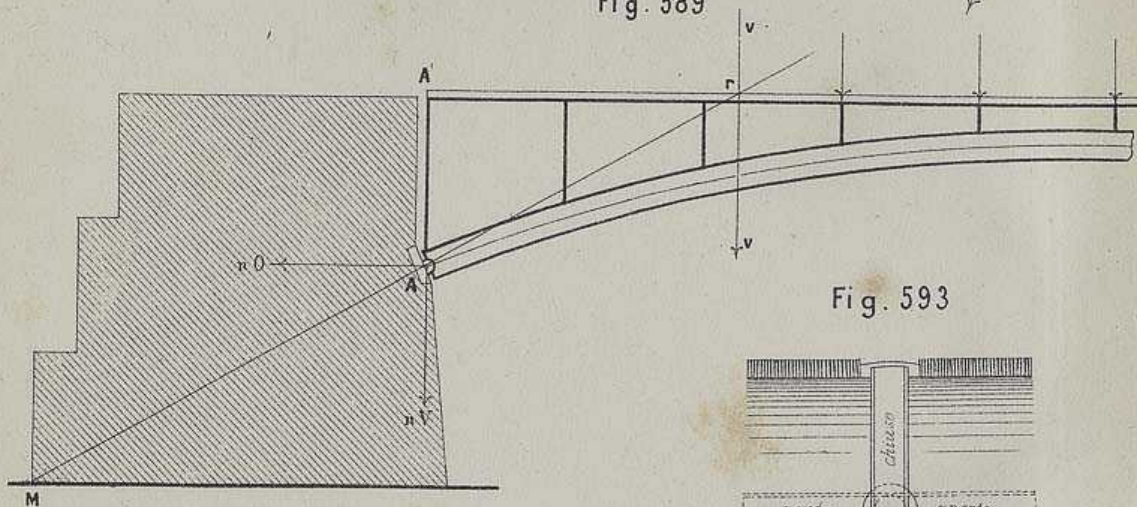

Fig. 592

Fig. 593

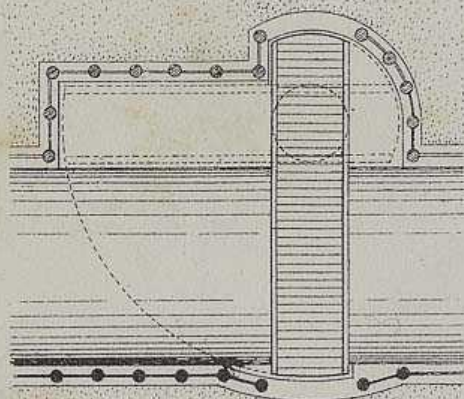
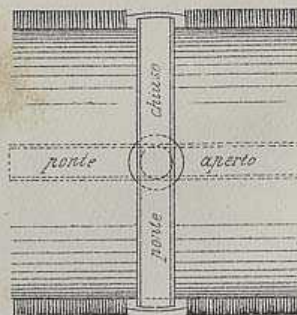

Fig. 595

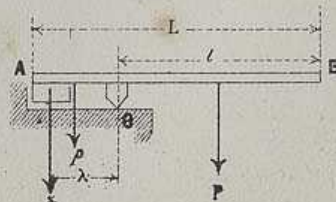



Fig. 587

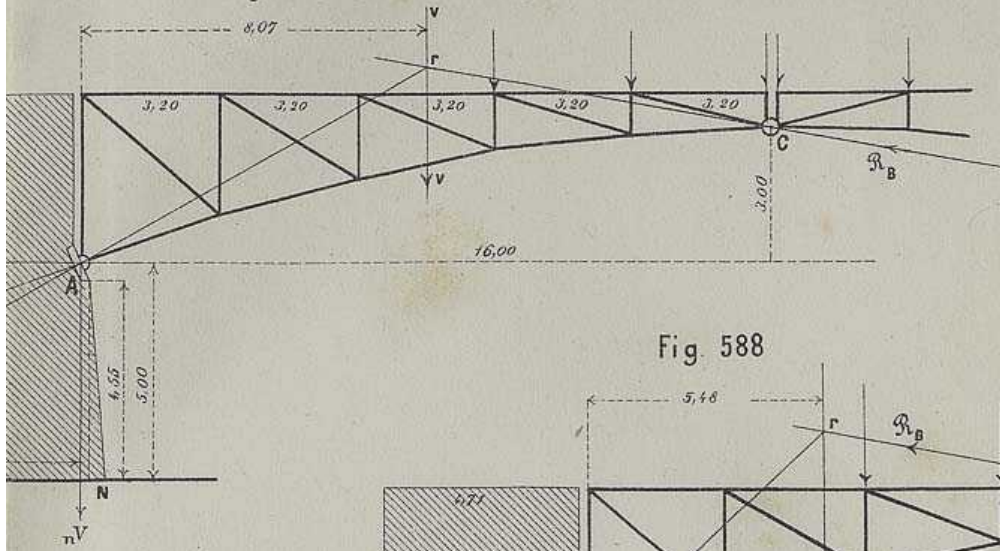

Fig. 588

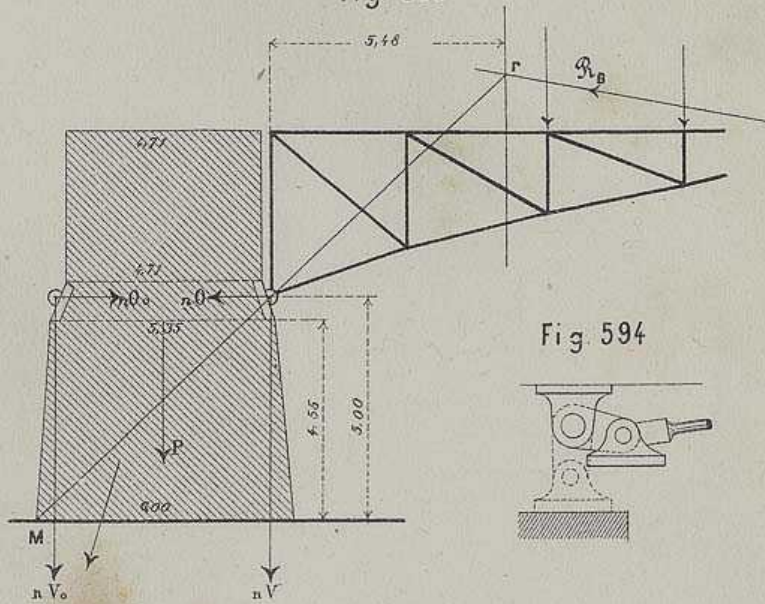

Fig. 594

Fig. 591

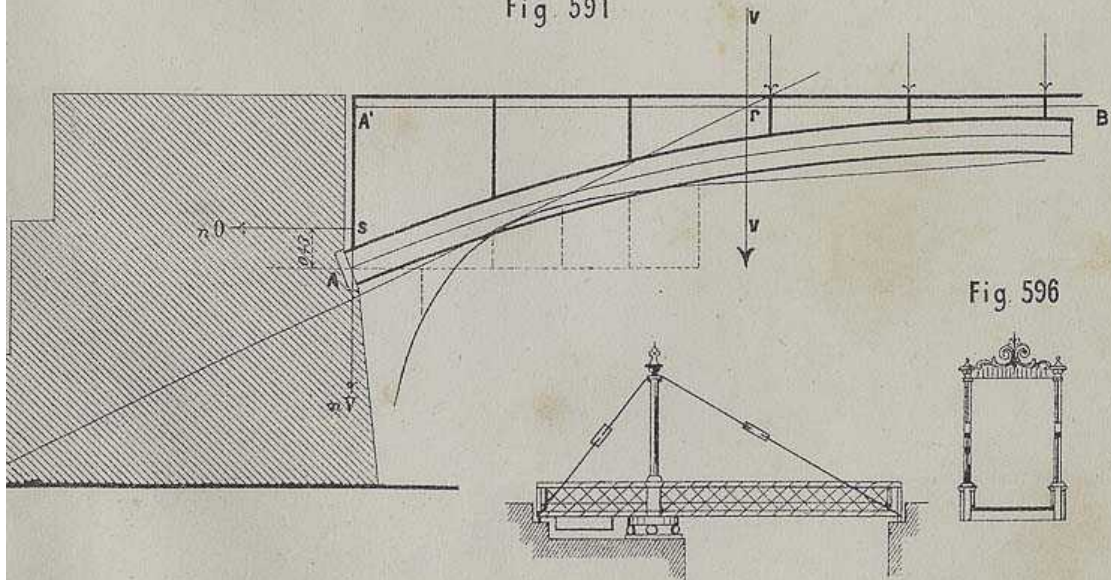

Fig. 596



Fig 598

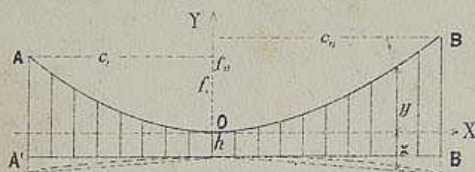

Fig 599

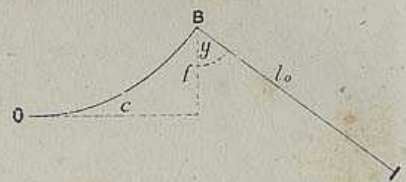

Fig 607

*Suolo, S. con dentatura*

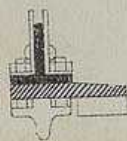
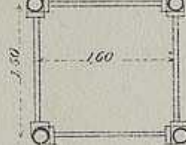

Fig. 606

*Sezione del pilone*



PONTE SO

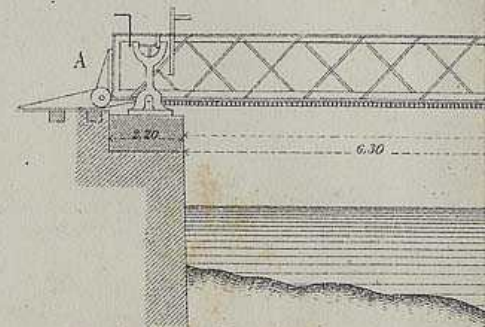
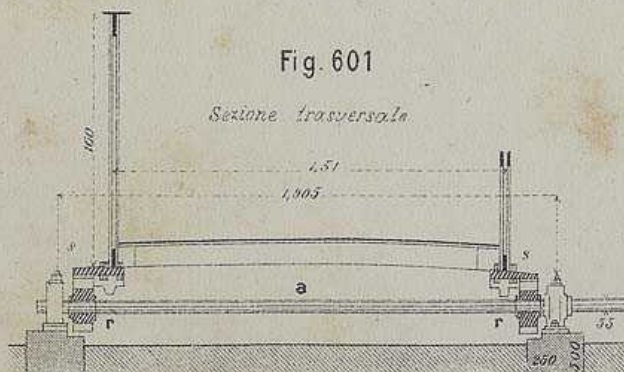

Fig. 601

*Sezione trasversale*



(3:100)

Fig. 604

*Dettaglio dell'estremo (A)*

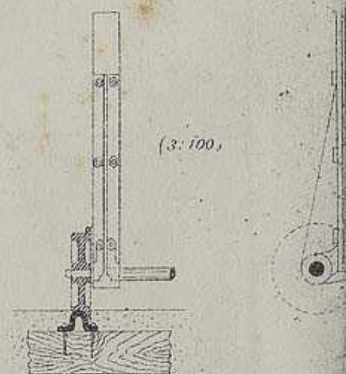

*Sezione orizzontale*

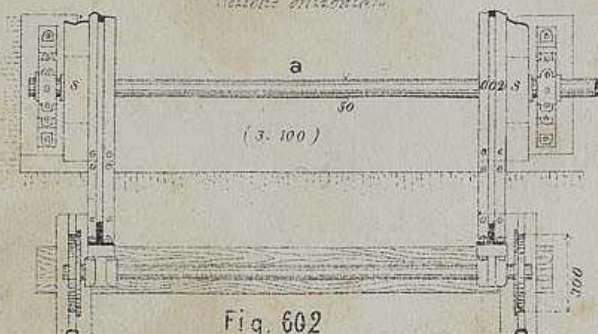
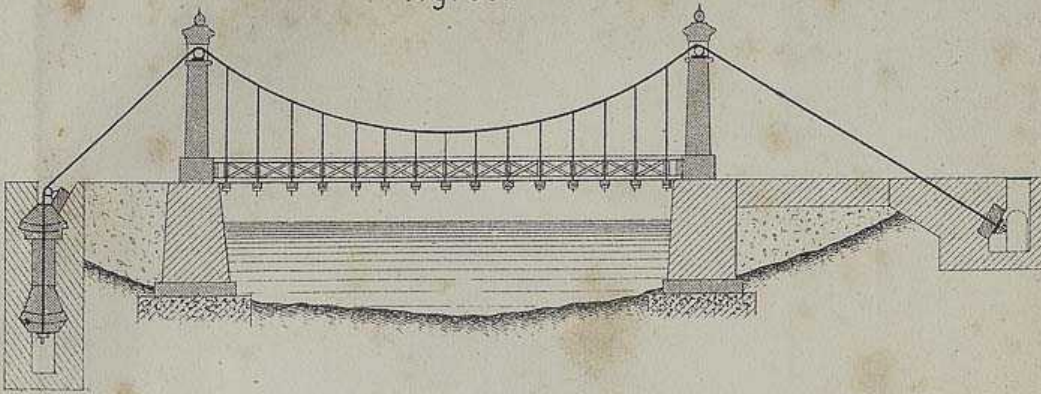

Fig. 602



Fig. 597



CORREVOLE PEDONALE IN ORIAGO

Fig. 600

Prospetto  
l. 11.30

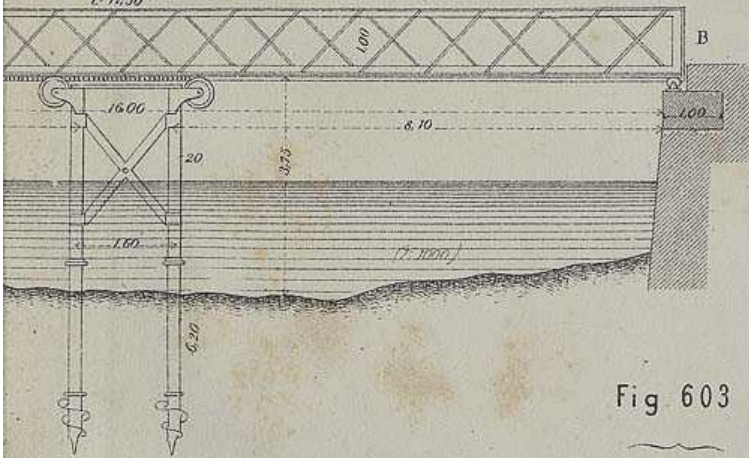

Fig. 605

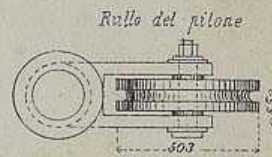

Fig. 603

Dettagli del Movimento

D<sup>o</sup> 15.76  
denti 12

D<sup>o</sup> 300 mm  
denti 36

D<sup>o</sup> 150  
denti 12  
D<sup>o</sup> 180  
denti 18

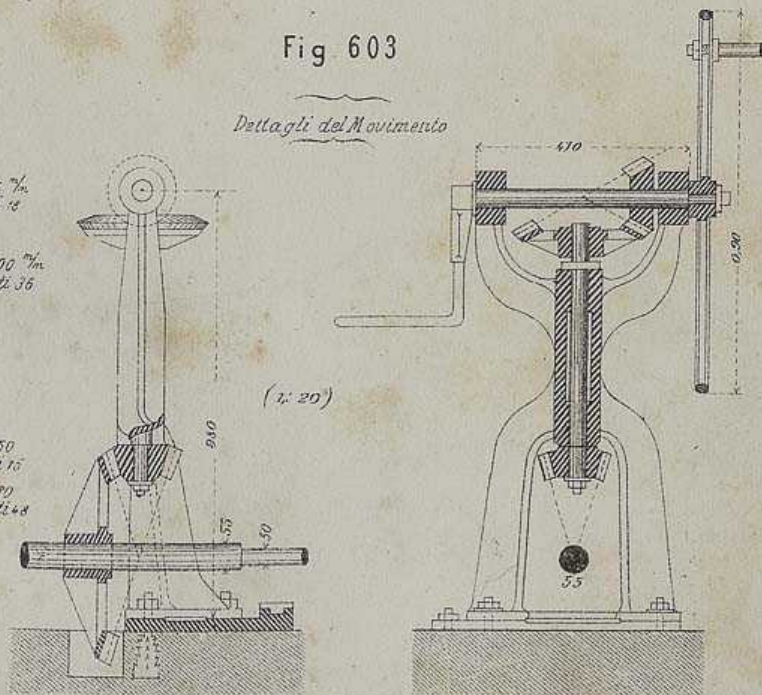



*N. d' Invent.* 13378



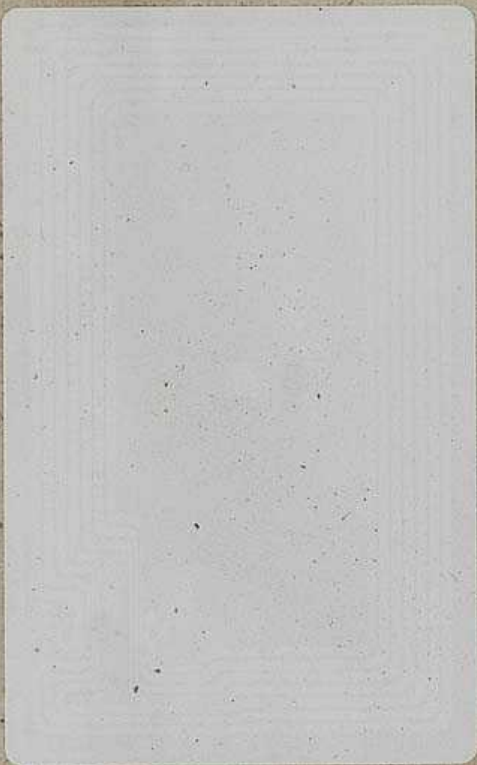

UNIVERSITA' DI PADOVA  
Biblioteca Centrale Ingegneria



REC000012730



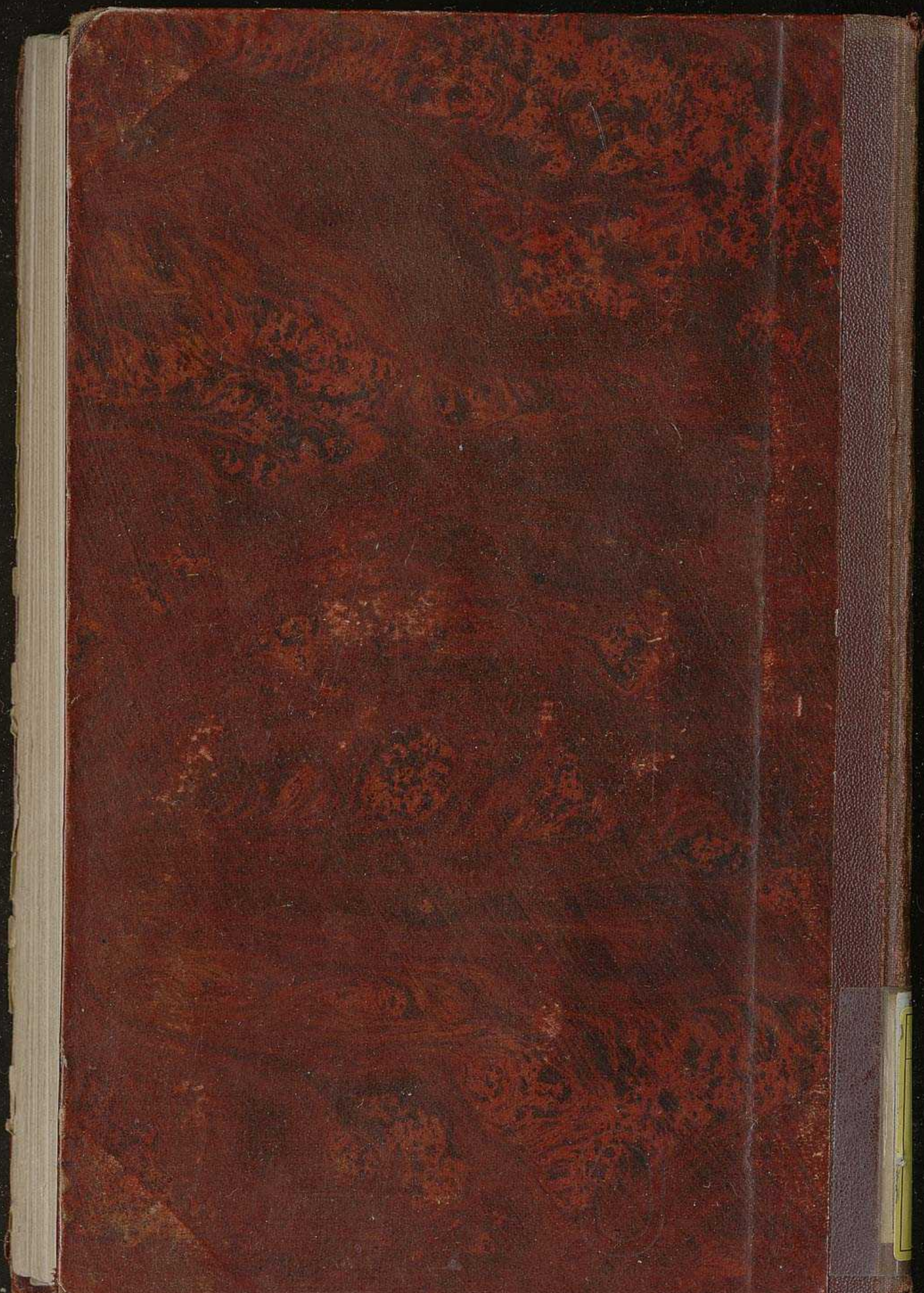



CHICCHI

PONTI  
METALLICI

UNIVERSITÀ DI PADOVA  
FACOLTÀ D'INGEGNERIA  
BIBLIOTECA CENTRALE

SILOS

IX

D

166.3